



كتالوج المنتجات

شركة أصول الزراعة للتجارة

عن الشركة

مقدمة عن شركة أصول الزراعة للتجارة

شركة أصول الزراعة للأنظمة الريادية في الزراعة

هي شركة رائدة في مجال الري والزراعة، متخصصة في تقديم حلول شاملة لتعزيز وتحسين العمليات الزراعية.

نحن ملتزمون بتقديم أحدث تقنيات الري والزراعة لضمان الاستخدام الفعال للمياه وزيادة الإنتاجية، مع الالتزام بمبادئ الاستدامة البيئية.

تقدم شركتنا مجموعة واسعة من الخدمات، بما في ذلك:

- تصميم وتنفيذ أنظمة الري الحديثة
- توفير المعدات الزراعية المتقدمة
- تقديم الاستشارات الفنية والدعم لمساعدة المزارعين على تحقيق أفضل إنتاجية للمحاصيل



قطع الربط

شد وصل نقاص

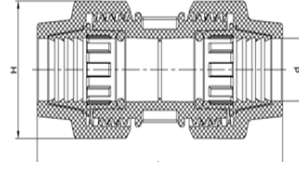
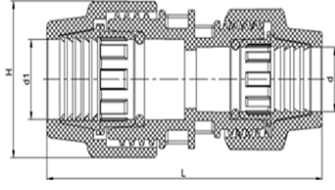

شد وصل

Size	H	L	d
20	45	103	20
25	55	112	25
32	62	132	32
40	79	159.3	40
50	96	186.5	50
63	114	229.5	63
75	232	131	75
90	257	154	90
110	299	183	110



Size	H	L	d	d
25*20	55	119	25	20
32*20	62	128.3	32	20
32*25	62	134.5	32	25
40*25	79	150	40	25
40*32	79	158.6	40	32
50*20	96	161	50	20
50*25	96	167.5	50	25
50*32	96	175.5	50	32
50*40	96	188.5	50	40
63*25	114	195.5	63	25
63*32	114	204	63	32
63*40	114	217	63	40

Size	H	L	d	d
63*50	114	228	63	50
75*50	215	129	75	50
75*63	230	129	75	63
90*32	219	149	90	32
90*50	234	149	90	50
90*63	250	149	90	63
90*75	279	149	90	75
110*32	256	182	110	32
110*50	256	182	110	50
110*63	270	182	110	63
110*75	308	182	110	75
110*90	323	182	110	90

بداية سن داخلي

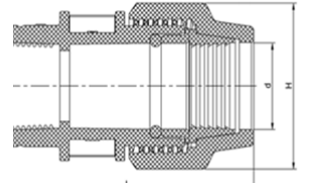

بداية سن خارجي

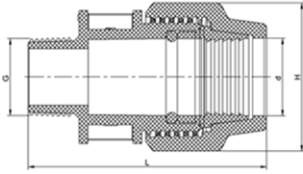

Size	H	L	d	G
20*1/2	45	77	20	1/2"
20*3/4	45	78	20	3/4"
20*1	45	80	20	1"
25*1/2	55	83.8	25	1/2"
25*3/4	55	84.5	25	3/4"
25*1	55	86.5	25	1"
32*1/2	62	94.5	32	1/2"
32*3/4	62	95	32	3/4"
32*1	62	97	32	1"
32*1 1/4	62	99	32	1 1/4"
40*1	79	111	40	1"
40*1 1/4	79	114	40	1 1/4"
40*1 1/2	79	116	40	1 1/2"
50*1	96	126	50	1"

Size	H	L	d	G
50*1 1/4	96	128	50	1 1/4"
50*1 1/2	96	130	50	1 1/2"
50*2	96	128.5	50	2"
63*1 1/4	114	161	63	1 1/4"
63*1 1/2	114	160.5	63	1 1/2"
63*2	114	163	63	2"
63*2 1/2	114	159.5	63	2 1/2"
75*2"	148	131	75	2"
75*2 1/2"	156	131	75	2 1/2"
75*3"	165	131	75	3"
90*2 1/2"	163	154	90	2 1/2"
90*3"	172	154	90	3"
90*4"	168	154	90	4"
110*3"	190	181	110	3"
110*4"	190	181	110	4"

Size	H	L	d	G
20*1/2	45	75.3	20	1/2"
20*3/4	45	75.3	20	3/4"
20*1	45	75.1	20	1"
25*1/2	55	80.8	25	1/2"
25*3/4	55	81	25	3/4"
25*1	55	84.5	25	1"
32*1/2	62	91.5	32	1/2"
32*3/4	62	91.7	32	3/4"
32*1	62	95.3	32	1"
32*1 1/4	62	102.5	32	1 1/4"
40*1	79	109	40	1"
40*1 1/4	79	111.5	40	1 1/4"
40*1 1/2	79	112	40	1 1/2"
50*1 1/4	96	125	50	1 1/4"
50*1 1/2	96	126	50	1 1/2"
50*2	96	129.5	50	2"
63*1 1/4	114	156.5	63	1 1/4"
63*1 1/2	114	156.5	63	1 1/2"
63*2	114	159	63	2"
75*2"	150	131	75	2"
75*2 1/2"	160	131	75	2 1/2"
75*3"	165	131	75	3"
90*2 1/2"	163	154	90	2 1/2"
90*3"	182	154	90	3"
90*4"	172	154	90	4"
110*3"	188	183	110	3"
110*4"	192	183	110	4"
20*1/2	45	75.3	20	1/2"
20*3/4	45	75.3	20	3/4"

قسام (تي)

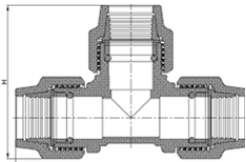

Size	H	L	d
20	89	127.5	20
25	100	134.5	25
32	116	171	32
40	142.5	206	40
50	168	244	50
63	209	307	63
75	323	228	75
90	260	260	90
110	450	225	110

قسم سن خارجي

قسم سن داخلي

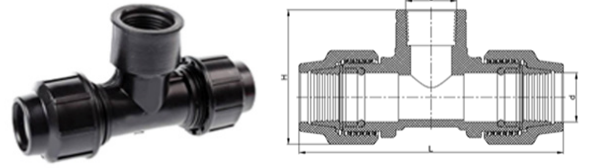
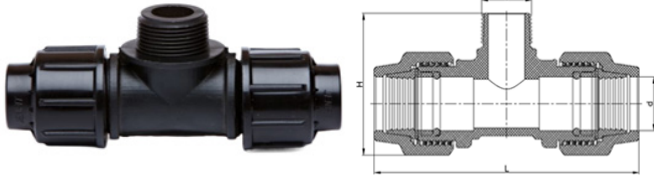

Size	H	L	d	G
20*1/2*20	62	129	20	1/2"
20*3/4*20	63.5	128	20	3/4"
20*1*20	66	128.2	20	1"
25*1/2*25	70	143.5	25	1/2"
25*3/4*25	71	143.3	25	3/4"
25*1*25	73	143	25	1"
32*1/2*32	78.5	184.2	32	1/2"
32*3/4*32	79.5	184	32	3/4"
32*1*32	79	185	32	1"
32*1 1/4*32	80	184.5	32	1 1/4"
40*1*40	105.5	221	40	1"
40*1 1/4*40	105	221	40	1 1/4"
40*1 1/2*40	105.5	221	40	1 1/2"
50*1*50	119	255.6	50	1"
50*1 1/4*50	120.5	256.5	50	1 1/4"
50*1 1/2*50	120	256.5	50	1 1/2"
50*2*50	121.5	256.5	50	2"
63*1 1/4*63	142.5	302.5	63	1 1/4"
63*1 1/2*63	140.5	301.5	63	1 1/2"
63*2*63	142	301.3	63	2"
75*1 1/2*75	165	340	75	1 1/2"
75*2*75	170	350	75	2"
75*2 1/2*75	175	350	75	2 1/2"
90*2 1/2*90	185	365	90	2 1/2"
90*3*90	190	365	90	3"
90*4*90	195	365	90	4"
110*3*110	216	450	110	3"
110*4*110	220	450	110	4"

Size	H	L	d	G
20*1/2*20	59.7	134.5	20	1/2"
20*3/4*20	59.5	134.5	20	3/4"
20*1*20	62	134	20	1"
25*1/2*25	67.5	143	25	1/2"
25*3/4*25	68	143.5	25	3/4"
25*1*25	69.8	143	25	1"
32*1/2*32	70.5	185	32	1/2"
32*3/4*32	70.5	184.5	32	3/4"
32*1*32	76	185	32	1"
40*3/4*40	88	221	40	3/4"
40*1*40	88	221.5	40	1"
40*1 1/4*40	88	221	40	1 1/4"
50*1 1/4*50	105.5	255.5	50	1 1/4"
50*1 1/2*50	106	255	50	1 1/2"
63*1 1/2*63	131	340	63	1 1/2"
63*2*63	131	340	63	2"
75*1 1/2*75	165	340	75	1 1/2"
75*2*75	170	350	75	2"
75*2 1/2*75	175	350	75	2 1/2"
90*2 1/2*90	185	365	90	2 1/2"
90*3*90	190	365	90	3"
90*4*90	195	365	90	4"
110*3*110	216	450	110	3"
110*4*110	220	450	110	4"

قسم ناقص

كوع

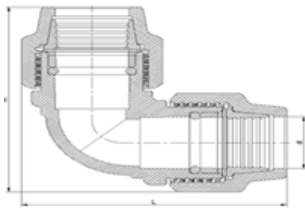

Size	H	L	d
20	86.5	86.5	20
25	99	99	25
32	115	115	32
40	141	141	40
50	168.5	168.5	50
63	206	206	63
75	230	230	75
90	261	261	90
110	317	317	110

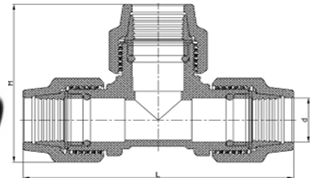

Size	H	L	d	d1
25*20*25	95	143.3	25	20
32*20*32	107	171.7	32	20
32*25*32	111	171.5	32	25
40*25*40	120	198.7	40	25
40*32*40	128.5	200	40	32
50*25*50	139.3	233	50	25
50*32*50	147.5	232.5	50	32
50*40*50	161	233.5	50	40
63*25*63	160	300	63	25
63*32*63	165	300	63	32
63*40*63	175	299.5	63	40
63*50*63	186.5	299	63	50
75*50*75	310	187	75	50
75*63*75	312	200	75	63
90*63*90	366	238	90	63
90*75*90	366	250	90	75
110*75*110	450	265	110	75
110*90*110	445	300	110	90

كوع سن داخلي

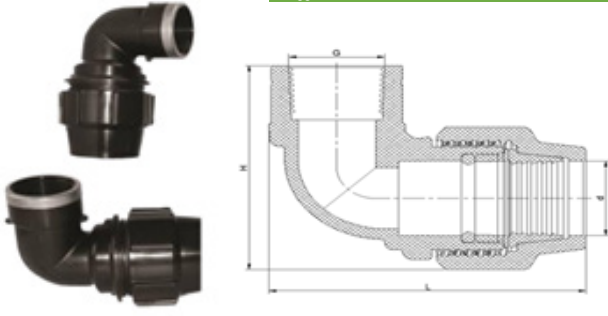

Size	H	L	d	G
20*1/2	60	85.5	20	1/2"
20*3/4	60	86	20	3/4"
20*1	62.3	86.7	20	1"
25*1/2	66.5	90.2	25	1/2"
25*3/4	68.5	90	25	3/4"
25*1	70	94.5	25	1"
32*1/2	83	111.5	32	1/2"
32*3/4	81	112	32	3/4"
32*1	83.2	116.8	32	1"
40*3/4	100	139	40	3/4"
40*1	100	138.5	40	1"
40*1 1/4	100	138.3	40	1 1/4"
40*1 1/2	100	138.5	40	1 1/2"
50*1 1/4	114	165	50	1 1/4"
50*1 1/2	115.8	165	50	1 1/2"
50*2	118	165	50	2"
63*1 1/2	136	205.3	63	1 1/2"
63*2	138	205.5	63	2"
63*2 1/2	140.2	203.5	63	2 1/2"
75*2	218	165	75	2"
75*2 1/2	215	165	75	2 1/2"
75*3	215	176	75	3"
90*2 1/2	250	185	90	2 1/2"
90*3	251	193	90	3"
90*4	250	193	90	4"
110*3	300	217	110	3"
110*4	294	219	110	4"

كوع سن خارجي

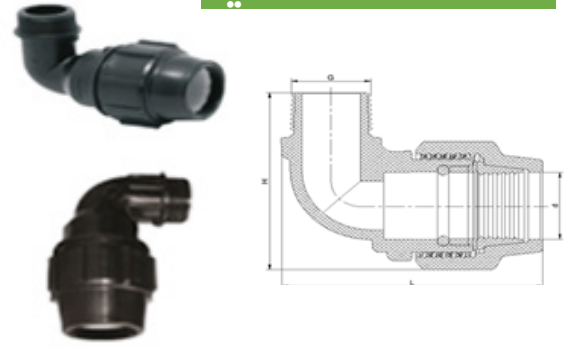

Size	H	L	d	G
20*1/2	61.5	81	20	1/2"
20*3/4	62.5	81.5	20	3/4"
20*1	64.5	81	20	1"
25*1/2	70.5	88	25	1/2"
25*3/4	70	88.5	25	3/4"
25*1	72	88.6	25	1"
32*1/2	84	111.3	32	1/2"
32*3/4	87.5	112	32	3/4"
32*1	86.5	111.5	32	1"
32*1 1/4	87.5	112	32	1 1/4"
40*1	106.5	136	40	1"
40*1 1/4	106.5	136	40	1 1/4"
40*1 1/2	107.5	136	40	1 1/2"
50*1 1/4	129	157	50	1 1/4"
50*1 1/2	129.5	158	50	1 1/2"
50*2	128	157.5	50	2"
63*1 1/4	143.5	195.5	63	1 1/4"
63*1 1/2	145.5	195.7	63	1 1/2"
63*2	148.5	196	63	2"
63*2 1/2	148.5	196	63	2 1/2"
75*2	210	153	75	2"
75*2 1/2	209	157	75	2 1/2"
75*3	207	165	75	3"
90*2 1/2	237	204	90	2 1/2"
90*3	237	204	90	3"
90*4	243	195	90	4"
110*3	290	213	110	3"
110*4	290	220	110	4"

محبس سن خارجي

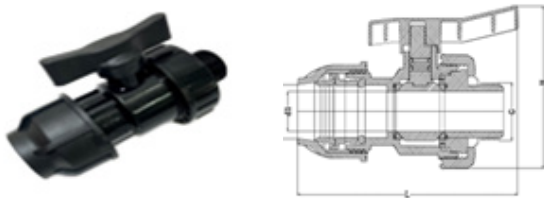

Size	L	H	d	d1	G	body thickness
20*1/2"	115	75	20	13.5	1/2"	2.1
25*3/4"	131	89	25	19.5	3/4"	2.5
32*1"	148	103	32	25	1"	3.2
40*1 1/4"	156	119	40	29.5	1 1/4"	3.5
50*1 1/2	188	142	50	36	1 1/2"	3.7
63*2	227	165	63	45.5	2"	4.1

محبس ربط

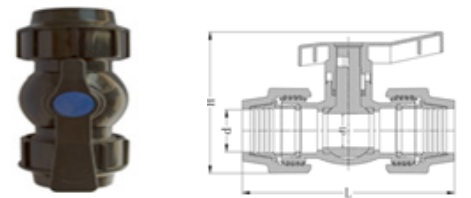

Size	L	H	d	d1	body thickness
20*20	133	90	20	13.5	2.1
25*25	150	104	25	19.5	2.5
32*32	175	115	32	25	3.3
40*40	175	116	40	31	4
50*50	215	136	50	39	4
63*63	260	156	63	49	4
75*75	375	183	75	62	4.9
90*90	425	205	90	74	6.5
110*110	490	253	110	89	10

نهاية ربط

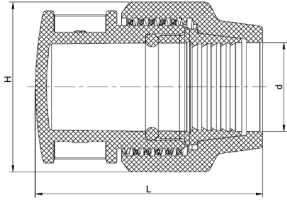

Size	H	L	d
20	45	65	20
25	55	75	25
32	62	82	32
40	79	97.3	40
50	96	113.5	50
63	114	142	63
75	127	131	75
90	139	154	90
110	159	182	110

محبس سن داخلي

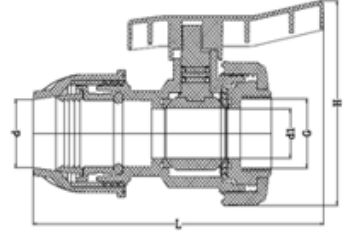

Size	L	H	d	d ₁	G	body thickness
20*1/2"	115	75	20	13.5	1/2"	2.1
25*3/4"	131	89	25	19.5	3/4"	2.5
32*1"	148	103	32	25	1"	3.2
40*1 1/4"	156	119	40	29.5	1 1/4"	3.5
50*1 1/2"	188	142	50	36	1 1/2"	3.7
63*2"	227	165	63	45.5	2"	4.1

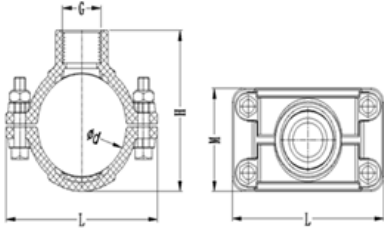

مربط

Size	L	M	H	d	G
20*1/2"	59	44.5	41.5	20	1/2"
25*1/2"	66	47	50	25	1/2"
25*3/4"	66	47	50	25	3/4"
32*1/2"	69	49	61	32	1/2"
32*3/4"	69	49	63	32	3/4"
32*1"	78	59	67	32	1"
40*1/2"	84	64	72.5	40	1/2"
40*3/4"	84	64	72.5	40	3/4"
40*1"	84	64	76	40	1"
50*1/2"	94	64	83	50	1/2"
50*3/4"	94	64	83	50	3/4"
50*1"	94	64	87	50	1"
50*1 1/4"	94	70	97	50	1 1/4"
50*1 1/2"	94	70	97	50	1 1/2"
63*1/2"	108	64	98.5	63	1/2"
63*3/4"	108	64	99.5	63	3/4"
63*1"	108	64	102.5	63	1"
63*1 1/4"	108	80	107	63	1 1/4"
63*1 1/2"	108	80	107	63	1 1/2"
63*2"	108	80	107	63	2"
75*1/2"	121	66	111	75	1/2"
75*3/4"	121	66	111	75	3/4"
75*1"	121	66	115	75	1"
75*1 1/4"	121	89	123	75	1 1/4"
75*1 1/2"	121	89	123	75	1 1/2"
75*2"	121	89	123	75	2"
90*1/2"	139	70	126.5	90	1/2"
90*3/4"	139	70	126.5	90	3/4"
90*1"	139	70	130	90	1"
90*1 1/4"	139	89	137	90	1 1/4"
90*1 1/2"	139	89	137	90	1 1/2"

Size	L	M	H	d	G
90*2"	139	89	137	90	2"
110*1/2"	159	76	133	110	1/2"
110*3/4"	159	76	133	110	3/4"
110*1"	159	76	133	110	1"
110*1 1/4"	159	89	158	110	1 1/4"
110*1 1/2"	159	89	158	110	1 1/2"
110*2"	159	89	158	110	2"
110*2 1/2"	161	125	165.5	110	2 1/2"
110*3"	161	125	169.5	110	3"
125*1/2"	170	99	155	125	1/2"
125*3/4"	170	99	156	125	3/4"
125*1"	170	99	158	125	1"
125*1 1/4"	170	99	161	125	1 1/4"
125*1 1/2"	170	99	162	125	1 1/2"
125*2"	170	99	164	125	2"
140*1/2"	185	99	175	140	1/2"
140*3/4"	185	99	176	140	3/4"
140*1"	185	99	178	140	1"
140*1 1/4"	185	99	180	140	1 1/4"
140*1 1/2"	185	99	180	140	1 1/2"
140*2"	185	99	180	140	2"
160*1/2"	201	89	204.5	160	1/2"
160*3/4"	201	89	204.5	160	3/4"
160*1"	201	89	206	160	1"
160*1 1/4"	201	89	208	160	1 1/4"
160*1 1/2"	201	89	208	160	1 1/2"
160*2"	201	89	210	160	2"
160*2 1/2"	210	136	214	160	2 1/2"
160*3"	210	136	217	160	3"
160*4"	210	136	231	160	4"

قطع البوشنج

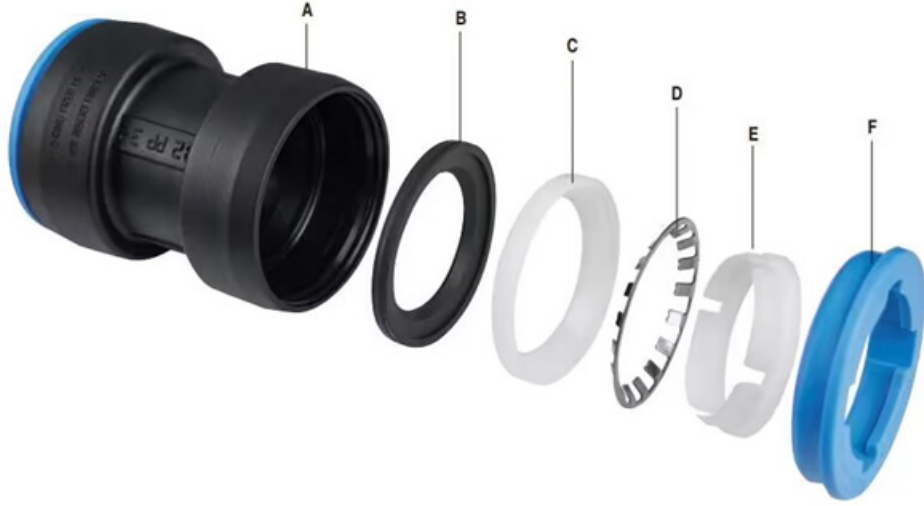

المادة	الجزء
بولي بروبيلين (PP-B) ذو خصائص ميكانيكية استثنائية حتى في درجات الحرارة العالية.	الهيكل (A)
مطاط أكريلونيتريل خاص (NBR) للاستخدام الغذائي.	حلقة العزل (B)
نايلون معزز (PA66+GF30)	حشوة الحجز (C)
فولاذ مقاوم للصدأ	حلقة التثبيت المعدنية (D)
راتنج بولي أسيتال (POM) ذو مقاومة ميكانيكية وصلابة عالية.	حلقة التثبيت (E)
بولي بروبيلين (PP-B) ذو خصائص ميكانيكية استثنائية حتى في درجات الحرارة العالية.	الغطاء (F)

كوع ٩٠°

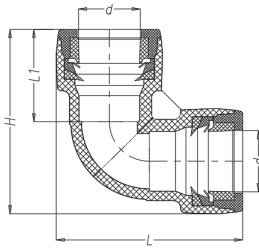

SIZE	L/mm	L1/mm	H/mm	d/mm	Weight/g
20	63.5	32.0	63.5	20.0	36.8
25	71.3	34.0	71.3	25.0	52.6
32	81.5	36.0	81.5	32.0	79.8

وصلة

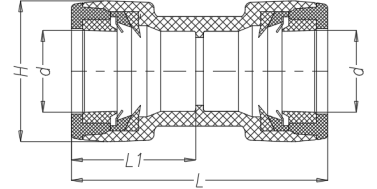

Z1001

SIZE	L/mm	L1/mm	H/mm	d/mm	Weight/g
20	66.5	32.0	36.5	20.0	32.5
25	70.3	34.0	44.4	25.0	47.3
32	74.0	36.0	52.0	32.0	68.0

قسام تي ٩٠°

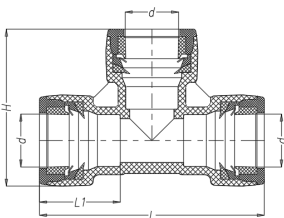

Z2001



SIZE	L/mm	L1/mm	H/mm	d/mm	Weight/g
20	89.0	32.0	62.5	20.0	53.5
25	97.5	34.0	70.3	25.0	77.3
32	109.0	36.0	80.0	32.0	111.4

وصلة ناقص

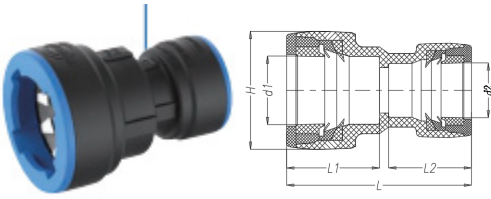

SIZE	L/mm	L1/mm	L2/mm	H/mm	d1/mm	d2/mm	Weight/g
25*20	67.5	34.0	32.0	44.4	25.0	20.0	41.5
32*20	70.1	36.0	32.0	52.0	32.0	20.0	53.7
32*25	72.0	36.0	34.0	52.0	32.0	25.0	60.0

بداية سن خارجي

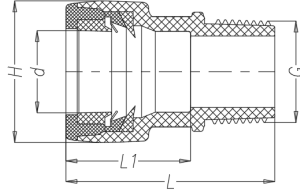

SIZE	L/mm	L1/mm	H/mm	d/mm	G	Weight/g
20*1/2	53.5	32.0	36.5	20.0	1/2"	19.9
20*3/4	53.5	32.0	36.5	20.0	3/4"	20.0
20*1	57.0	32.0	36.5	20.0	1"	24.4
25*1/2	55.0	34.0	44.4	25.0	1/2"	28.7
25*3/4	55.0	34.0	44.4	25.0	3/4"	28.6
25*1	61.0	34.0	44.4	25.0	1"	31.4
32*1/2	58.0	36.0	52.0	32.0	1/2"	41.4
32*3/4	58.0	36.0	52.0	32.0	3/4"	41.4
32*1	64.0	36.0	52.0	32.0	1"	45.0

بداية سن داخلي

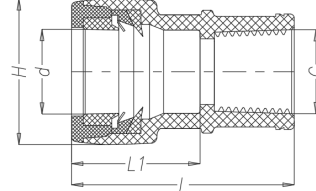

SIZE	L/mm	L1/mm	H/mm	d/mm	Weight/g
20*1/2	54.6	32.0	36.5	20.0	24.9
25*1/2	56.5	34.0	44.5	25.0	31.9
25*3/4	57.0	34.0	44.5	25.0	32.7
25*1	60.5	34.0	44.5	25.0	42.2
32*1/2	59.5	36.0	52.0	32.0	44.1
32*3/4	60.0	36.0	52.0	32.0	46.6

قسام سن داخلي 90°

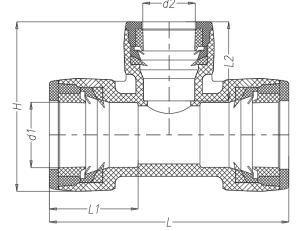

SIZE	L/mm	L1/mm	L2/mm	H/mm	d1/mm	d2/mm	Weight/g
25*20*25	88.7	34.0	32.0	82.9	25.0	20.0	68.8
32*20*32	94.7	36.0	32.0	74.2	32.0	20.0	93.0
32*25*32	99.7	36.0	34.0	76.0	32.0	25.0	101.4

قسام تي ناقص 90°

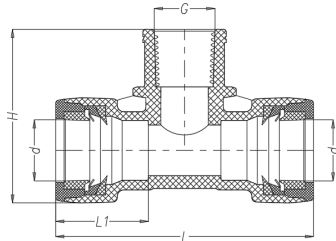

SIZE	L/mm	L1/mm	H/mm	d/mm	G	Weight/g
20*1/2	82.0	32.0	55.2	20.0	1/2"	45.7
20*3/4	86.0	32.0	55.7	20.0	3/4"	49.2
20*1	90.0	32.0	59.7	20.0	1"	58.2
25*1/2	86.0	34.0	61.9	25.0	1/2"	60.8
25*3/4	91.0	34.0	61.9	25.0	3/4"	65.8
25*1	95.0	34.0	65.9	25.0	1"	67.3
32*1/2	90.9	36.0	70.3	32.0	1/2"	84.5
32*3/4	96.6	36.0	70.3	32.0	3/4"	90.2
32*1	99.9	36.0	74.3	32.0	1"	97.7

قسام سن خارجي 90°

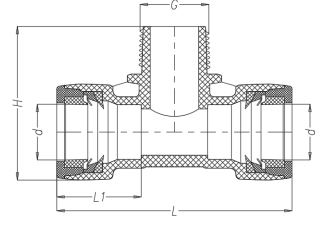

SIZE	L/mm	L1/mm	H/mm	d/mm	G	Weight/g
20*1/2	82.0	32.0	53.0	20.0	1/2"	39.9
20*3/4	82.0	32.0	53.0	20.0	3/4"	48.2
20*1	82.0	32.0	57.3	20.0	1"	44.2
25*1/2	86.0	34.0	59.9	25.0	1/2"	55.8
25*3/4	91.0	34.0	59.6	25.0	3/4"	57.5
25*1	91.0	34.0	63.7	25.0	1"	60.2
32*1/2	87.0	36.0	68.3	32.0	1/2"	80.4
32*3/4	93.0	36.0	68.1	32.0	3/4"	82.9
32*1	93.0	36.0	72.1	32.0	1"	86.3

كوع سن خارجي ٩٠°

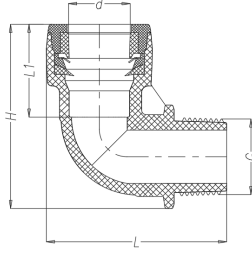

SIZE	L/mm	L1/mm	H/mm	d/mm	G	Weight/g
20*1/2	61.0	32.0	62.0	20.0	1/2"	24.6
20*3/4	61.0	32.0	64.3	20.0	3/4"	28.6
20*1	64.0	32.0	67.0	20.0	1"	31.0
25*1/2	66.8	34.0	64.8	25.0	1/2"	32.7
25*3/4	66.8	34.0	67.0	25.0	3/4"	37.8
25*1	70.8	34.0	69.8	25.0	1"	38.0
32*1/2	74.3	36.0	67.2	32.0	1/2"	46.1
32*3/4	74.3	36.0	74.2	32.0	3/4"	50.4
32*1	76.3	36.0	74.2	32.0	1"	51.0

كوع سن داخلي ٩٠°

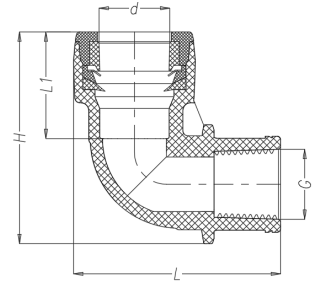

SIZE	L/mm	L1/mm	H/mm	d/mm	G	Weight/g
20*1/2	58.2	32.0	66.9	20.0	1/2"	32.2
20*3/4	58.2	32.0	70.1	20.0	3/4"	33.5
25*1/2	64.3	34.0	66.5	25.0	1/2"	37.7
25*3/4	64.3	34.0	69.7	25.0	3/4"	42.4
32*1/2	65.3	36.0	72.8	32.0	1/2"	51.5
32*3/4	71.4	36.0	77.0	32.0	3/4"	57.7
32*1	78.9	36.0	78.6	32.0	1"	64.3

قسام ري

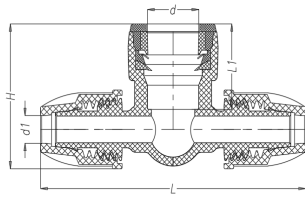

SIZE	L/mm	L1/mm	H/mm	d/mm	d1/mm	Weight/g
16*20*16	97.0	32.0	55.5	20.0	16.0	42.3
20*20*20	103.0	32.0	56.5	20.0	20.0	51.3
16*25*16	103.0	34.0	56.5	25.0	16.0	49.3
20*25*20	109.0	34.0	61.0	25.0	20.0	59.9
25*25*25	119.0	34.0	66.8	25.0	25.0	73.5
16*32*16	109.0	36.0	58.8	32.0	16.0	64.7
20*32*20	115.0	36.0	62.9	32.0	20.0	73.5
25*32*25	125.0	36.0	69.1	32.0	25.0	87.8

قسام تي ناقص ٩٠°

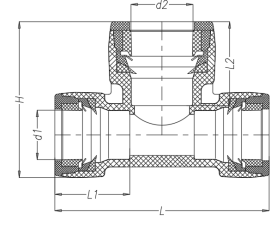

SIZE	L/mm	L1/mm	L2/mm	H/mm	d1/mm	d2/mm	Weight/g
20*25*20	91.5	32.0	34.0	59.0	20.0	25.0	61.1
20*32*20	96.8	32.0	36.0	60.5	20.0	32.0	73.7
25*32*25	101.7	34.0	36.0	71.5	25.0	32.0	89.2

قسام ري

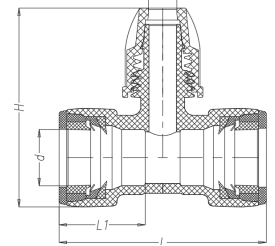

SIZE	L/mm	L1/mm	H/mm	d/mm	d1/mm	Weight/g
20*16*20	75.8	32.0	67.2	20.0	16.0	46.4
25*16*25	79.7	34.0	73.9	25.0	16.0	61.1
25*20*25	73.2	34.0	80.3	25.0	20.0	67.6
32*16*32	94.9	36.0	82.2	32.0	16.0	89.3
32*20*32	88.6	36.0	87.4	32.0	20.0	121.3
32*25*32	93.1	36.0	87.6	32.0	25.0	98.1

محبس بوشنج

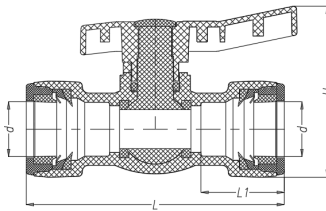

SIZE	L/mm	L1/mm	H/mm	d/mm	Weight/g
20	103.5	32.0	65.6	20.0	69.5
25	107.0	34.0	81.0	25.0	109.2
32	130.1	36.0	98.5	32.0	174.2

محبس سن داخلي

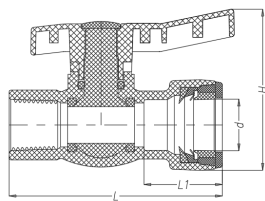

SIZE	L/mm	L1/mm	H/mm	d/mm	Weight/g
20*1/2	92.0	32.0	65.6	20.0	59.5
25*3/4	103.0	34.0	81.0	25.0	123.8
32*1	123.3	36.0	98.5	32.0	154.3

سدة

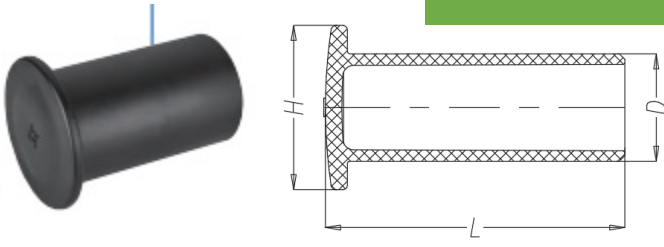

SIZE	L/mm	H/mm	d/mm	Weight/g
20	55.0	30.0	20.0	9.7
25	56.2	35.0	25.0	14.0
32	57.9	42.0	32.0	19.6

نهاية بوشنج

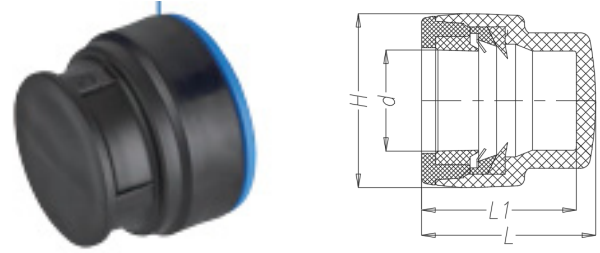

SIZE	L/mm	L1/mm	H/mm	d/mm	Weight/g
20	36.0	32.0	36.5	20.0	18.6
25	38.5	34.0	44.4	25.0	26.3
32	40.5	36.0	52.0	32.0	38.7

قسام تي عالمي سن خارجي

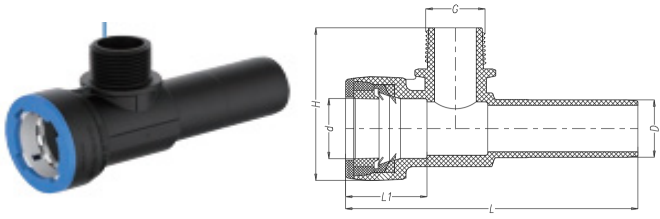

SIZE	L/mm	L1/mm	H/mm	d/mm	D/mm	G	Weight/g
25*1/2*25	119.6	34.0	59.9	25.0	25.0	1/2"	45.1
25*3/4*25	119.6	34.0	59.9	25.0	25.0	3/4"	47.4
32*1/2*32	136.0	36.0	68.0	32.0	32.0	1/2"	67.2
32*3/4*32	136.0	36.0	68.0	32.0	32.0	3/4"	67.9
32*1*32	136.0	36.0	74.1	32.0	32.0	1"	72.3

قسام تي عالمي

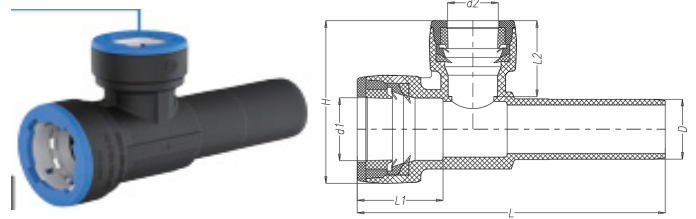

SIZE	L/mm	L1/mm	L2/mm	H/mm	d1/mm	d2/mm	D/mm	Weight/g
25*20*25	119.6	34.0	32.0	65.8	25.0	20.0	25.0	56.7
32*20*32	135.8	36.0	32.0	73.9	32.0	20.0	32.0	77.0
32*25*32	135.8	36.0	34.0	75.8	32.0	25.0	32.0	84.3

مفتاح

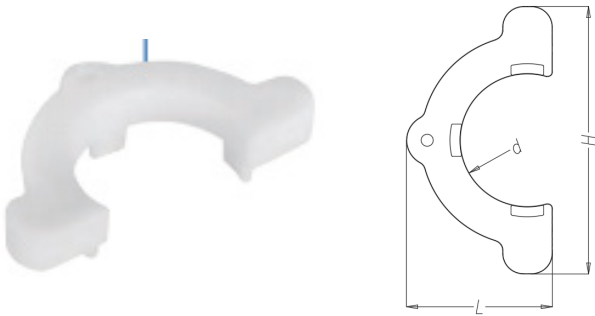

SIZE	L/mm	H/mm	d/mm	Weight/g
20	27.0	49.0	20.0	5.9
25	30.5	53.7	25.0	6.9
32	35.5	64.2	32.0	9.4

كوع عالمي

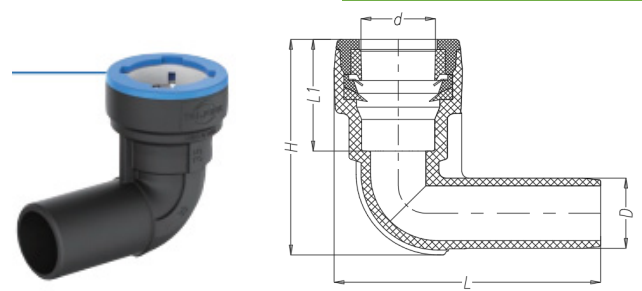

SIZE	L/mm	L1/mm	H/mm	d/mm	Weight/g
20*20	84.5	32.0	60.7	20.0	25.2
25*25	90.9	34.0	67.5	25.0	37.3
32*32	102.4	36.0	77.9	32.0	58.6

قطع اللحام

قسام تي

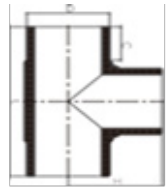

Size	H	L	C	H
T63*63	63	210	65	105
T75*75	75	250	73	125
T90*90	90	280	80	140
T110*110	110	310	82	155
T125*125	125	320	87	160
T140*140	140	354	92	177
T160*160	160	372	80	190
T180*180	180	423	105	210
T200*200	200	420	105	210
T225*225	225	470	110	235

كوع ٤٥°

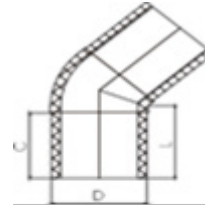

Size	D	L	C
L63	63	29.4	35.5
L75	75	73	85
L90	90	78	90
L110	110	80	95
L125	125	95	105
L160	160	95	115
L200	200	110	130
L225	225	120	125
L250	250	112	125
L315	315	110	125

وصلة ناقص

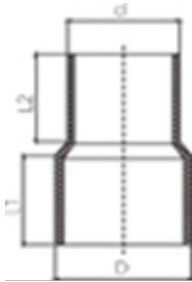

Size	H	L	C	H	
S75*63	75	63	144	73	65
S90*50	90	50	154	79	55
S90*63	90	63	157	78	65
S90*75	90	75	159	78	73
S110*50	110	50	167	82	55
S110*63	110	63	169	80	65
S110*75	110	75	171	80	73
S110*90	110	90	168	80	78
S125*75	125	75	170	80	75
S125*90	125	90	200	85	85
S125*110	125	110	187.5	90	90
S160*63	160	63	221	82	85
S160*75	160	75	221	89	90
S160*90	160	90	221	96	85
S160*110	160	110	220	106	90
S160*125	160	125	215	100	90
S180*90	180	90	255	80	85
S180*140	180	140	180	80	86
S200*90	200	90	260	90	113
S200*110	200	110	260	100	110
S200*160	200	160	260	105	120
S225*110	225	110	257.7	95	95
S225*160	225	160	242.5	100	110
S225*200	225	200	242.5	80	105
S250*110	250	110	240	110	85
S250*160	250	160	280	102	135
S250*200	250	200	275	115	120
S315*110	315	110	210.5	70	90
S315*160	315	160	205.5	72	85
S315*200	315	200	267	105	120
S315*250	315	250	263	105	125
S400*315	400	315	312.5	95	135
S450*250	450	250	90	92	235
S450*315	450	315	90	100	235
S500*250	500	250	90	120	255
S500*315	500	315	90	122	255
S500*400	500	400	310	95	130
S630*500	630	500	335	100	135

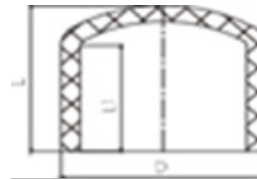

نهاية

Size	D	L
63	63	77.9
75	75	90
90	90	95
110	110	95
125	125	105
140	140	115.5
160	160	120
180	180	135
200	200	140
225	225	130
250	250	125
280	280	130
315	315	150
355	355	157
400	400	165
450	450	157
500	500	170
560	560	196
630	630	196

قسام تي نقاص



Size	H	d2	L	C1	C2	H
T63*50	63	50	210	65	55	95
T75*50	75	50	250	73	55	107
T75*63	75	63	250	73	65	117
T90*50	90	50	280	80	55	110
T90*63	90	75	280	80	65	120
T90*75	90	75	280	80	73	129
T110*50	110	50	310	82	60	135
T110*63	110	63	310	82	65	140
T110*75	110	75	310	82	80	145
T110*90	110	90	310	82	80	155
T125*50	125	50	320	87	55	128
T125*63	125	63	320	87	63	136
T125*75	125	75	320	87	70	143
T125*90	125	90	320	87	80	152
T125*110	125	110	320	87	82	155
T140*63	140	63	354	92	65	150
T140*75	140	75	354	92	70	155
T140*90	140	90	354	92	79	164
T140*110	140	110	354	92	82	167
T140*125	140	125	354	92	87	152
T160*50	160	50	372	90	65	155
T160*63	160	63	372	90	65	160
T160*75	160	75	372	90	70	165

Size	H	d2	L	C1	C2	H
T160*90	160	90	372	90	80	175
T160*110	160	110	372	90	90	185
T180*110	180	110	423	105	82	188
T180*125	180	125	423	105	87	193
T180*140	180	140	423	105	92	198
T180*160	180	160	423	105	98	204
T200*63	200	63	420	108	65	181
T200*75	200	75	420	108	75	200
T200*90	200	90	420	108	90	200
T200*110	200	110	420	108	90	200
T200*160	200	160	420	108	90	200
T225*110	225	110	470	110	83	222
T225*160	225	160	470	110	98	222
T225*200	225	200	470	110	110	235
T250*110	250	110	465	90	95	230
T250*160	250	160	465	90	100	240
T250*200	250	200	465	90	120	255
T315*110	315	110	520	90	90	260
T315*160	315	160	520	90	90	265
T315*200	315	200	520	90	90	280
T315*225	315	225	520	95	105	290
T315*250	315	250	520	95	120	290
T400*110	400	110	500	100	110	
T400*160	400	160	500	100	110	
T400*200	400	200	500	100	110	
T400*250	400	250	500	100	110	
T400*315	400	315	500	100	110	

فلنجة بشفة

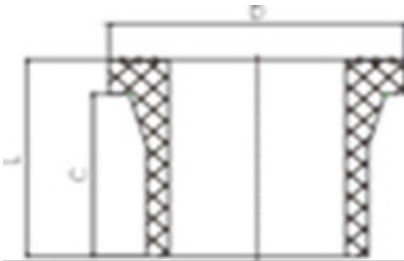

Size	D	d2	L	C
F50	88	50	88	75
F63	102	63	100	85
F75	120	75	110	94
F90	138	90	120	102
F110	150	110	120	102
F125	158	125	130	110
F140	188	140	130	108
F160	205	160	120	98
F180	212	180	140	115
F200	268	200	150	122
F225	268	225	150	120
F250	315	250	145	120
F280	320	280	140	140

Size	D	d2	L	C
F315	370	315	160	150
F355	430	355	170	130
F400	480	400	210	158
F450	525	450	180	135
F500	580	500	220	170
F630	685	630	230	180
F710	800	710	215	165
F800	900	800	215	160

كوع ٩٠°

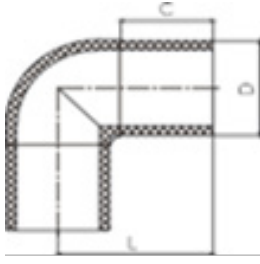

Size	D	C	L
L63	63	65	108
L75	75	73	125
L90	90	78	140
L110	110	82	155
L125	125	87	160
L140	140	92	177
L160	160	85	182
L180	180	105	211
L200	200	95	210
L225	225	110	235
L250	250	90	235
L315	315	105	272
L355	355	120	280
L400	400	110	330
L500	500	120	450
L560	560	125	700
L630	630	130	410
L710	710	180	911
L800	800	180	1002

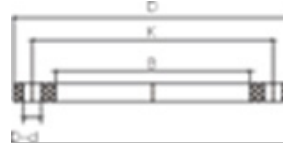

فلنجة حديد مبطنه

Size	D	K	B	n	D2
63	165	125	77	4	18
75	185	145	90	4	18
90	200	160	106	8	18
110	220	180	126	8	18
125	250	210	135	8	18
160	285	240	178	8	22
200	340	295	234	8	22
225	340	295	241	8	22
250	405	355	287	12	26
315	460	410	337	12	26
355	505	460	369	16	22
400	565	515	418	16	26
450	615	565	460	20	25
500	670	620	517	20	26
630	780	725	650	20	30
800	1015	950	825	24	33

قسام رباعي ناقص

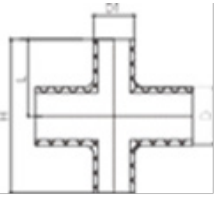

Size	D	D2	H	L
110*63	110	63	279	123
110*75	110	75	279	130
110*90	110	90	279	137
160*63	160	63	329	147
163*75	160	75	329	154
160*90	160	90	329	162
160*110	160	110	329	165
200*160	200	160	379	185
200*110	200	110	379	185
250*110	250	110	461	221
250*160	250	160	461	211
250*200	250	200	461	216
315*110	315	110	543	248
315*160	315	160	543	248
315*200	315	200	543	253
315*250	315	250	543	268

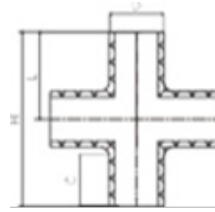

Size	D	L	H	C
63	63	210	105	55
90	90	280	140	80
110	110	290	145	82
160	125	378	189	105
200	160	444	222	112
250	200	514	257	120
315	225	574	287	120
63	63	210	105	55
90	90	280	140	80
110	110	290	145	82
160	125	378	189	105
200	160	444	222	112
250	200	514	257	120
315	225	574	287	120

بداية سن داخلي



Size	D	d2	D3	L	H	G
20*1/2"	27.6	19.2	37.2	16.5	38.5	1/2"
25*1/2"	32.8	24.2	37.2	18.1	40.1	1/2"
25*3/4"	32.8	24.2	44.7	18.1	43.6	3/4"
32*1/2"	41.4	31.2	37.2	20.1	42.1	1/2"
32*3/4"	41.4	31.2	44.7	20.1	45.6	3/4"
32*1"	41.4	31.2	54.3	20.1	49.9	1"
40*1-1/4"	50.2	39	67.2	22.5	62.4	1-1/4"
50*1-1/2"	63.1	49.1	73.6	22.5	55.6	1-1/2"
63*2"	77.9	61.9	90.2	29.4	61	2"

بداية سن خارجي

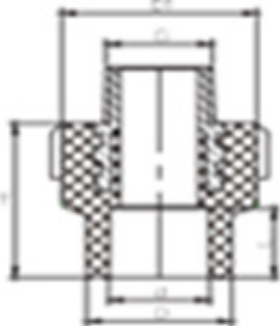

Size	D	d2	D3	L	H	G
20*1/2"	27.6	19.2	37.2	16.5	36.5	1/2"
25*1/2"	32.8	24.2	37.2	18.1	38.1	1/2"
25*3/4"	32.8	24.2	44.7	18.1	39.8	3/4"
32*1/2"	41.4	31.2	37.2	20.1	40.1	1/2"
32*3/4"	41.4	31.2	44.7	20.1	41.8	3/4"
32*1"	41.4	31.2	54.3	20.1	47.2	1"
40*1-1/4"	50.2	39	67.2	22.5	52.3	1-1/4"
50*1-1/2"	63.1	49.1	73.6	22.5	56.3	1-1/2"
63*2"	77.9	61.9	90.2	29.4	61.2	2"

كوع سن خارجي

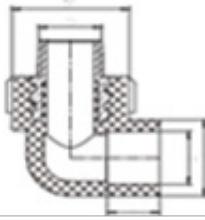

Size	D	d2	D3	L	G
20*1/2"	27.6	19.2	37.2	16.5	1/2"
25*1/2"	32.8	24.2	37.2	18.1	1/2"
25*3/4"	32.8	24.2	44.7	18.1	3/4"
32*1/2"	41.4	31.2	37.2	20.1	1/2"
32*3/4"	41.4	31.2	44.7	20.1	3/4"
32*1"	41.4	31.2	54.3	20.1	1"

كوع سن داخلي



Size	D	d2	D3	L	G
20*1/2"	27.6	19.2	37.2	16.5	1/2"
25*1/2"	32.8	24.2	37.2	18.1	1/2"
25*3/4"	32.8	24.2	44.7	18.1	3/4"
32*1/2"	41.4	31.2	37.2	20.1	1/2"
32*3/4"	41.4	31.2	44.7	20.1	3/4"
32*1"	41.4	31.2	54.3	20.1	1"

وصلة سن داخلي

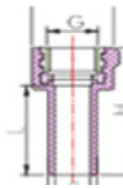

Size	D	d2	D3	L	H	G
20*1/2"	20.2	14.6	33.6	45.1	64.3	1/2"
25*3/4"	25.2	19.2	40.5	44.5	67	3/4"
32*1"	32.2	25.8	49.1	50	74.8	1"
40*1-1/4"	40.2	32	61.2	52	81.1	1-1/4"
50*1-1/2"	50.2	40.4	70.4	59	88.5	1-1/2"
63*2"	63.2	51	87.4	70.1	98.1	2"
75*2-1/2"	75.2	60.6	108.6	80	109.8	2-1/2"
90*3"	90.2	72.6	128.2	90	123.2	3"
110*4"	110.2	88.8	159.2	95	136.1	4"

قسام تي سن خارجي

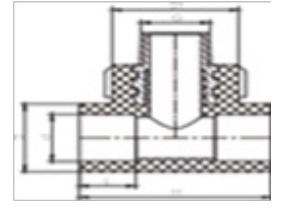

Size	D	d2	D3	L	H	G
20*1/2"	27.6	19.2	37.2	16.5	56.4	1/2"
25*1/2"	32.8	24.2	37.2	18.1	64.2	1/2"
25*3/4"	32.8	24.2	44.7	18.1	64.2	3/4"
32*1/2"	41.4	31.2	37.2	20.1	70	1/2"
32*3/4"	41.4	31.2	44.7	20.1	76	3/4"
32*1"	41.4	31.2	54.3	20.1	81.2	1"

قسم تي سن داخلي

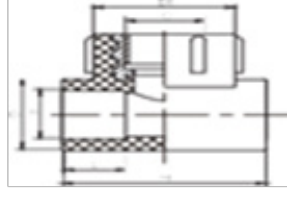

وصلة سن خارجي

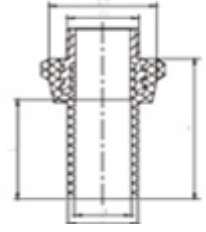

Size	D	d2	D3	L	H	G
20*1/2"	27.6	19.2	37.2	16.5	53.5	1/2"
25*1/2"	32.8	24.2	37.2	18.1	63	1/2"
25*3/4"	32.8	24.2	44.7	18.1	63	3/4"
32*1/2"	41.4	31.2	37.2	20.1	74	1/2"
32*3/4"	41.4	31.2	44.7	20.1	74	3/4"
32*1"	41.4	31.2	54.3	20.1	74	1"

Size	D	d2	D3	L	H	G
20*1/2"	20.2	14.6	31.6	44.5	62.3	1/2"
25*3/4"	25.2	19.2	38.8	47	66.5	3/4"
32*1"	32.2	25.8	47.8	52.3	76.5	1"
40*1-1/4"	40.2	32	59	54.4	79.6	1-1/4"
50*1-1/2"	50.2	40.4	67.8	58.4	87.8	1-1/2"
63*2"	63.2	51	83.1	70	98	2"
75*2-1/2"	75.2	60.6	103.5	81	109	2-1/2"
90*3"	90.2	72.6	120.4	88.5	121.4	3"
110*4"	110.2	88.8	150.8	92	133	4"

Size	D	d2	D3	L	H	G
20	27.6	19.2	37.2	70.8	41.8	1/2"
25	32.8	24.2	44.7	83	49.85	3/4"
32	41.4	31.2	44.7	68.5	57.9	1"
40	50.2	39	54.3	98.8	70	1-1/4"
50	63.1	49.1	64.7	123.8	85.35	1-1/2"
63	77.9	61.9	37.1	134.7	100.2	2"

محبس إيقاف

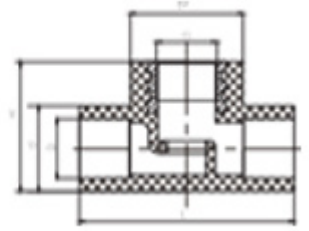

اكتروفيجين

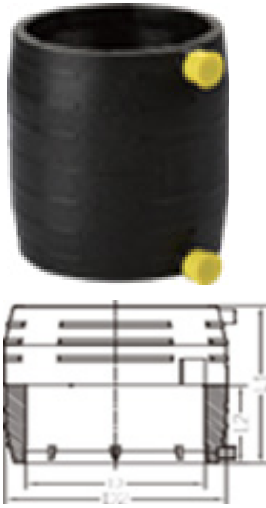

Size	D	d2	D3
20	31	80	39.5
25	36	81	40
32	43	87	43
40	52	87	43
50	63	87	43
63	79	114	56
75	96	126	62
90	113	135	66.5
110	138	151	74.5
125	157	172	85

وصلة

Size	D	d2	D3
160	200	184	91
180	225	191	94.5
200	250	223	110.5
225	287	235	116.5
250	312	248	123
280	348	262	130
315	392	285	141.5
400	499	328	163
500	617	364	181

نهاية

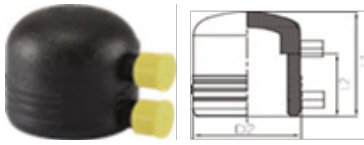

Size	D	L	L2
20	31	68	39.5
25	36	68	40
32	43	68	43
40	52	68	43
50	63	76	43
63	79	88	56
75	96	105.6	62
90	113	111	66.5
110	138	132	74.5
125	157	158.4	85
160	200	168	91
200	250	201.6	110.5
250	312	237	123
315	392	265	141.5

كوع ٤٥

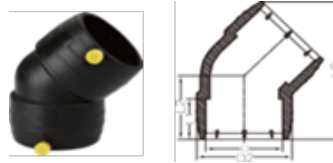

Size	D2	L	L2	L3
20	31	39.5	50	94.3
25	36	40	51	88
32	43	43	55	107
40	52	43	57	114.5
50	63	43	59	121.6
63	79	56	81	164
75	96	62	88	181
90	113	66.5	96	199
110	138	74.5	109	230
125	157	85	128	268.5
160	200	91	142.5	307.5
180	225	94.5	155	336.3
200	250	110.5	177	382.7
250	312.1	123	190	431
315	392.3	141	227	522

كوع ٩٠



Size	D2	L	L2	L3
20	31	39.5	56	70.8
25	36	40	58	75.8
32	43	43	65	76.4
40	52	43	70	96
50	63	43	75	106.5
63	79	56	97	136.5
75	96	62	112	160
90	113	66.5	124	180.3
110	138	74.5	145	214
125	157	85	165	243.2
160	200	91	194	294
180	225	94.5	210	322.6
200	250	110.5	240	365.6
250	312.1	123	270	427
315	392.3	141	327	523

قسام تي

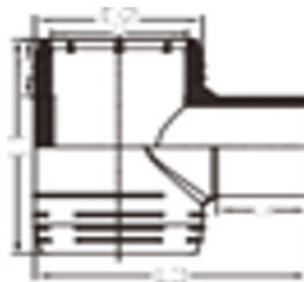

Size	D2	L	L2	L3	L4
20	31	100	39.5	80.2	45
25	36	107	40	85.2	45
32	43	120	43	97.3	50
40	52	128	43	111.4	55
50	63	138	43	128.4	60
63	79	178	56	157	70
75	96	202	62	179.6	75
90	113	226	66.5	207	85
110	138	262	74.5	240	90
125	157	298	85	262	90
160	200	345	91	328	110
200	250	425	110.5	390	120
250	312	503	123	471	142
315	392	605	141	594	165

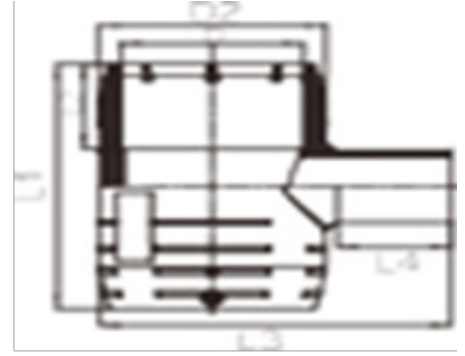

Size	D2	L	L2	L3	L4
25*20	36	102	40	85.2	45
32*20	43	108	43	92.3	45
32*25	43	113	43	92.3	45
40*20	52	108	43	101.4	45
40*25	52	113	43	101.4	45
40*32	52	120	43	106.4	50
50*20	63	108	43	112.4	45
50*25	63	113	43	112.4	45
50*32	63	120	43	117.4	50
50*40	63	128	43	122.4	55
63*20	79	135	56	128.5	45
63*25	79	140	56	128.5	56
63*32	79	147	56	133.5	50
63*40	79	155	56	138.5	55
63*50	79	165	56	144.5	60
75*50	100.5	176	62	165	60
75*63	100.5	202	62	183.2	75
90*32	113	168	66.5	167	50
90*40	113	176	66.5	172	55
90*50	113	186	66.5	178	60
90*63	113	199	66.5	190.5	70
90*75	113	199	66.5	190.5	70
110*32	138	184	74.5	192.2	50
110*40	138	192	74.5	197.2	55
110*50	138	202	74.5	203	60

Size	D2	L	L2	L3	L4
110*63	138	215	74.5	215.7	70
110*75	138	227	74.5	221	75
110*90	138	242	74.5	232	85
125*63	156	236	85	235	70
125*75	156	248	85	240	75
125*90	156	263	85	251	85
125*110	156	283	85	259	90
160*63	200	248	91	278	70
160*75	200	259	91	284.2	75
160*90	200	275	91	295	85
160*110	200	295	91	303	90
200*63	250	315	110.5	329	70
200*75	250	295	110.5	336	75
200*90	250	315	110.5	345	85
200*110	250	335	110.5	353	90
200*160	250	385	110.5	378	110
250*90	312	338	123	413	85
250*110	312	359	123	418	90
250*160	312	411	123	438	110
250*200	312392	452	123	452	123
315*90	392	374	141	508	85
315*110	392	395	141	514	90
315*160	392	477	141	534	110
315*200	392	488	141	548	123
315*250	392	539	141	567	142

قطع مسننة

نقاص سن داخلي

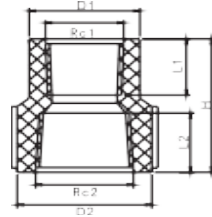

Size	Rc1	Rc2	D1	D2	L1	L2	H
3/4"×1/2"	1/2"	3/4"	30	36.5	17.5	18.5	41.6
1"×1/2"	1/2"	1"	58	74.6	43.5	92.5	120
1"×3/4"	3/4"	1"	36.5	44	18.5	22	45.5
1-1/2"×3/4"	3/4"	1 1/2"	36.5	60.8	18.5	25	52.5
1-1/2"×1"	1"	1 1/2"	44	60.8	22	25	56

ريزر

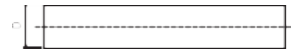

Size	d1	d2
1/2"	1M	0.75M
3/4"	1M	0.75M
1"	1M	0.75M

نبل

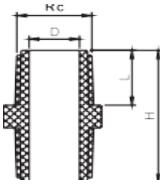

Size	Rc1	L1	L2	H
1/2"	1/2"	17	41	13.4
3/4"	3/4"	18.5	45	18.4
1"	1"	22	54.2	25.2
1-1/4"	1-1/4"	24	54	31.5
1-1/2"	1-1/2"	25	56	36.5
2"	2"	29	60.5	47.5
2-1/2"	2-1/2"	31.5	69	64
3"	3"	33	73.5	74.6
4"	4"	36.5	96.2	132.5

كوع سن داخلي

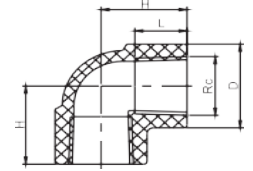

Size	Rc1	L1	L2	H
1/2"	1/2"	17.5	28	30
3/4"	3/4"	18.5	32.75	36.5
1"	1"	22	39.5	44
1-1/4"	1-1/4"	24	47	54.6
1-1/2"	1-1/2"	25	49	60.4
2"	2"	29	61.2	74
2-1/2"	2-1/2"	31.5	72	93.3
3"	3"	33	79.15	104.6
4"	4"	36.5	96.2	132.5

جبلة

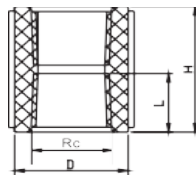

Size	Rc	L	H	D
1/2"	1/2"	17.5	37.5	30
3/4"	3/4"	18.5	40.3	36.5
1"	1"	22	48.3	44
1-1/4"	1-1/4"	24	40.3	51.5
1-1/2"	1-1/2"	25	56	60.8
2"	2"	29	59	74.2
2-1/2"	2-1/2"	31.5	63	95.7
3"	3"	33	66	109.4
4"	4"	36.5	78	135.6

قسام تي سن داخلي

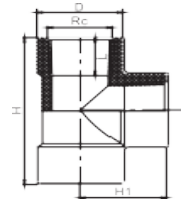

Size	Rc	L	D	H	H1
1/2"	1/2"	17	30	56.6	28.4
3/4"	3/4"	18.5	36.5	65.5	32.8
1"	1"	22	44	87	44.5
1-1/4"	1-1/4"	24	53.4	94	47
1-1/2"	1-1/2"	25	60.2	99	49.5
2"	2"	29	74	120.4	60.2
2-1/2"	2-1/2"	31.5	93.3	144	72
3"	3"	33	105.6	158.3	79.15
4"	4"	37.5	132.8	194.4	97.2

قسم تي نقص سن داخلي

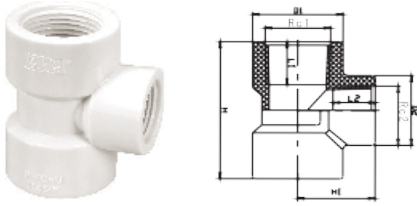

Size	Rc1	Rc2	L1	L2	D1	D2	H1
3/4"×1/2"	3/4"	1/2"	18.5	18.5	36.5	30	59
1"×1/2"	1"	1/2"	51	19.8	58	32	67
1"×3/4"	1"	3/4"	22.6	18.5	44	36.5	72.3
1-1/2"×1/2"	1 1/2"	1/2"	25	17	60.8	30	79
1-1/2"×3/4"	1 1/2"	3/4"	25	18.5	60.8	36.5	85
1-1/2"×1"	1 1/2"	1"	25	22.6	60.8	44	93
2"×1/2"	2"	1/2"	28	17	74	30	86
2"×3/4"	2"	3/4"	28	18.5	74	36.5	92
2"×1"	2"	1"	28	22.6	74	44	98
2"×1-1/2"	2"	1-1/2"	28	25	74	60.8	103.8

جبلة

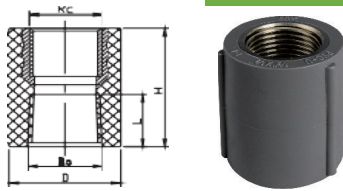

Size	Rc	L	H	D
1/2"	1/2"	17.5	37.5	32
3/4"	3/4"	18	42.5	36
3/4"×1/2"	3/4"×1/2"	18	42.5	36

كوع سن داخلي

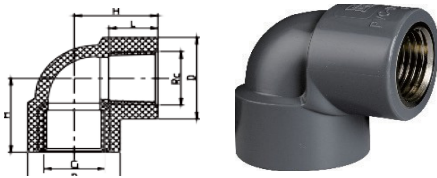

Size	Rc	L	H
29	29	29	29

نقص سن داخلي وخارجي

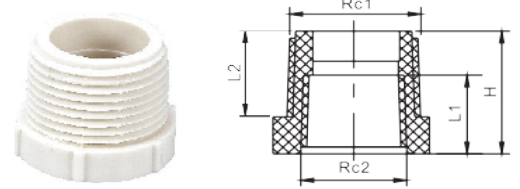

Size	Rc1	Rc2	L1	L2	H
3/4"×1/2"	3/4"	1/2"	17	18.5	26.5
1"×1/2"	1"	1/2"	17	22.6	31
1"×3/4"	1"	3/4"	18.5	22.6	31.6
1-1/4"×3/4"	1 1/4"	3/4"	18.5	22.5	31.5
1-1/4"×1"	1 1/4"	1"	22	22.5	31.5
1-1/2"×3/4"	1 1/2"	3/4"	18.5	23	33
1-1/2"×1"	1 1/2"	1"	22	23	33
1-1/2"×1-1/4"	1 1/2"	1 1/4"	24.5	23	33
2"×3/4"	2"	3/4"	26	18.5	37
2"×1"	2"	1"	22	26	37
2"×1-1/4"	2"	1-1/4"	24.5	26	37
2"×1-1/2"	2"	1-1/2"	25	26	37
2-1/2"×3/4"	2-1/2"	3/4"	29	1.5	40
2-1/2"×1"	2-1/2"	1"	29	21	40
2-1/2"×1-1/2"	2-1/2"	1-1/2"	29	25	40
2-1/2"×2"	2-1/2"	2"	28	29	40
3"×2"	3"	2"	31	32	34
3"×2-1/2"	3"	2-1/2"	28	32	3
4"×2"	4"	2"	28	38	50
4"×3"	4"	3"	34	38	50

كوع نقص

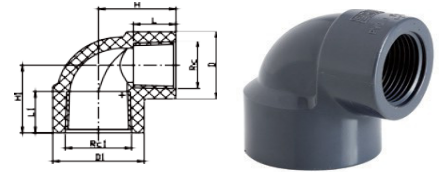

Size	Rc1	Rc2	L1	D1	D2	H1	H2
3/4"×1/2"	3/4"	1/2"	18.5	36.5	32	31	32.5
1"×1/2"	1"	1/2"	22.6	44	32	37.5	32.6
1"×3/4"	1"	3/4"	22.6	44	36.5	36.5	34.5
1-1/2"×1/2"	1 1/2"	1/2"	25	60.8	44	42	44.5
1-1/2"×3/4"	1 1/2"	3/4"	25	60.8	44	42.5	44.5
1-1/2"×1"	1 1/2"	1"	25	60.8	44	46.5	46.5

كوع سن داخلي وخارجي

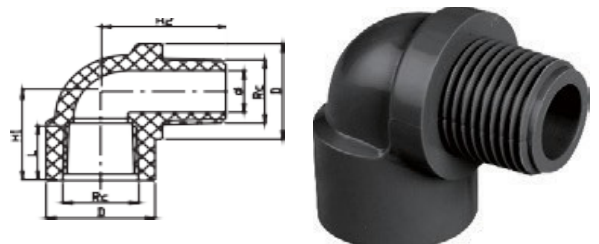

Size	Rc	L	H	D	H2
1/2"	1/2"	17.5	28	30	34.5
3/4"	3/4"	18.5	32.75	36.5	39.55
1"	1"	22	39.5	44	46.8
1-1/4"	1-1/4"	24	40.3	51.5	50
1-1/2"	1-1/2"	25	51.5	60.8	59.4
2"	2"	28	61	74	69.5
2-1/2"	2-1/2"	31	72.5	93.2	82.5

وصلة سن داخلي وخارجي

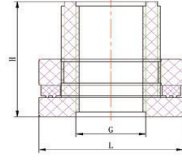

Size	Rc	L	H
3/4"	3/4"	54.8	48

نبل نقاص

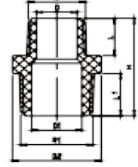

Size	Rc1	Rc2	L1	L2	H	D1	D2
3/4"×1/2"	3/4"	1/2"	17	18.5	43.5	13.4	32.2
1"×1/2"	1"	1/2"	17	21	47	13.4	40
1"×3/4"	1"	3/4"	18.5	21	48.5	18.4	40
1-1/4"×1"	1 1/4"	1"	21	22.5	52.5	22.6	47
1-1/2"×1-1/4"	1 1/2"	1 1/4"	22.5	23	55.5	31.4	53.5
2"×1-1/2"	2"	1-1/2"	23	26	59	36.6	/
2-1/2"×2"	2-1/2"	2"	26	29	65	47	/
3"×2"	3"	2"	26	32	68	47	/
3"×2-1/2"	3"	2-1/2"	29	32	71	60	/
4"×3"	4"	3"	32	40.5	80	70.6	/

قسام تي سن داخلي

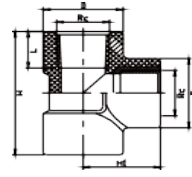

Size	Rc	L	H	D	H1
1/2"	1/2"	17	29	32	31

سدة بسن

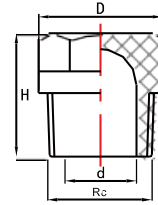

Size	Rc	D	d2	H
1/2"	1/2"	24	13	26.5
3/4"	3/4"	31	17.8	31
1"	1"	39.2	23	37.5
1-1/4"	1-1/4"	43.3	31.5	36
1-1/2"	1-1/2"	50	36.5	38.5
2"	2"	57	47.5	43
2-1/2"	2-1/2"	82	60	52.5
3"	3"	94	70.6	57.5
4"	4"	120	93.4	63.5

قسام نقاص سن داخلي

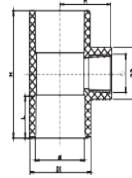

Size	Rc1	Rc2	L1	L2	D1	D2	H1	H2
3/4"×1/2"	3/4"	1/2"	18.5	18.5	36.5	32	67	32.5
1"×1/2"	1"	1/2"	22.6	19.8	44	32	73	37.5

جلبة نقاص

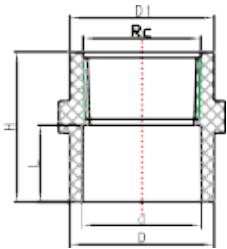

Size	Rc	L	H	D	D2	d3
1/2"	1/2"	17.5	35.5	28.5	21.34	28.5
3/4"	3/4"	20	41	34.5	26.67	34.5
1"	1"	23	45.5	41.7	33.4	41.7
1-1/4"	1-1/4"	27.5	53.7	51.4	42.16	51.4
1-1/2"	1-1/2"	30.5	62	59.4	48.26	59.4
2"	2"	36.5	76	76	60.33	76
3"	3"	51	100	103.5	88.9	105
4"	4"	63.5	120	134.5	114.3	136

محابس الكترونية

ADI



سلسلة ADI هي خط إنتاج من محابس التحكم البلاستيكية الهيدروليكية لأنظمة الري السكنية والتجارية والزراعية. يجمع محبس التحكم البلاستيكي هذا، الذي يعمل هيدروليكيًا باستخدام غشاء، بين بساطة التصميم والموثوقية والأداء الهيدروليكي الممتاز.

محابس سلسلة ADI هي محابس بلاستيكية متينة. صُنع جسم المحبس وغطاؤه وقرص الختم من النايلون المملوء بالزجاج لتحمل ظروف التشغيل القاسية، مما يضمن مقاومة عالية للمواد الكيميائية والتجفيف.

يتضمن تصميم جسم المحبس مقعدًا كامل التجويف مع مسار تدفق خالٍ من أي أضلاع خطية أو ففص دعم أو أعمدة.

Dimensions

1" F BSPT

2" F BSPT

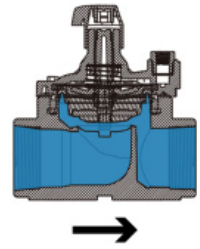
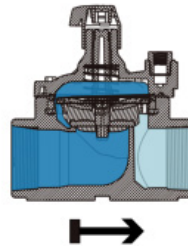

- الغطاء - تصميم بسيط وخفيف الوزن يُتيح فحصًا وخدمة سريعة داخل الخط.
- زنبرك إغلاق مساعد - زنبرك واحد يُلبى تمامًا متطلبات الصمام لنطاق ضغط التشغيل، مما يضمن ضغط فتح منخفض وإغلاقًا مُحكمًا.
- مجموعة السدادة - تتضمن مجموعة قرص السدادة غشاءً مرناً ومتوازنًا بعناية ومدعومًا محيطيًا، وسدادة توجيه متينة بسطح مانع تسرب مطاطي.
- الجسم - نايلون مملوء بالزجاج لتلبية ظروف الخدمة القاسية، مما يوفر مقاومة عالية للمواد الكيميائية والتجفيف.
- مقعد كامل التجويف مع مسار تدفق خالٍ من أي عوائق داخل الخط، أو ففص دعم، أو أعمدة.

الميزات والفوائد الرئيسية

- محبس متين وعالي الجودة، مصنوع من النايلون المملوء بالألياف الزجاجية، لظروف التشغيل القاسية.
- مقعد كامل التجويف لتدفق فائق السرعة مع أدنى حد من فقدان الضغط.
- قطع أقل، تصميم هيكلي بسيط، وسهولة التركيب والصيانة.
- مقبض توصيل يوفر ضبطًا دقيقًا للتدفق.
- تنظيم دقيق ومستقر للضغط، تشغيل مستقر، وضغوط بدء وتشغيل منخفضة.
- غشاء عالي الجودة، مقاوم للتآكل والتشوه.

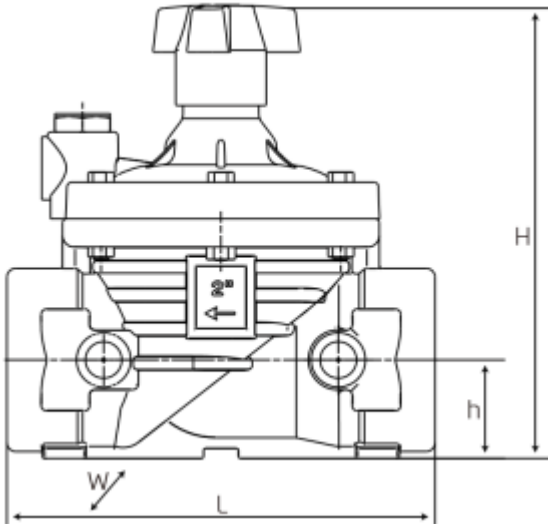



محابس التحكم الهيدروليكية البلاستيكية عالية الأداء من AMA يجمع محبس التحكم الهيدروليكي من AMA بين بساطة التصميم والموثوقية والأداء المتفوق. وهو مصنوع من نايلون صناعي متين مملوء بالزجاج، ومصمم لتحمل ظروف التشغيل القاسية، مما يوفر مقاومة فائقة للتآكل ومقاومة عالية لدرجات الحرارة المنخفضة. يتضمن تصميم جسم صمام التحكم من AMA مقعدًا كامل التجويف مع مسار تدفق خالٍ من العوائق، أو الأضلاع المستقيمة، أو أقفاص الدعم، أو الأعمدة. يوفر الغشاء المرن الموحد Super Travel والمانع التسرب الموجه مروراً سلساً من أحد الطرفين إلى الطرف الآخر، مما ينتج عنه سعة تدفق فائقة مع أدنى حد من فقدان الضغط.

Dimensions
1" F BSPT
2.5" F BSPT
3" F BSPT
3" Flange
3L" Flange
4" Flange

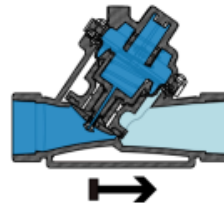

Close

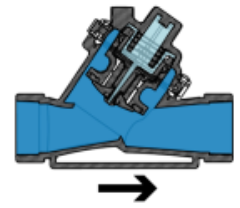

Open

- الغطاء - يلبي هيكل الغطاء المتين متطلبات الصيانة الصارمة.
- زنبرك إغلاق مساعد - يوفر زنبرك واحد عالي الجودة من الفولاذ المقاوم للصدأ نطاق تشغيل واسع، مما يضمن ضغط فتح منخفضاً وإغلاقاً آمناً للزنبرك للإغلاق المساعد.
- مجموعة السدادة - تجمع مجموعة السدادة المرنة فائقة السفر (FST) بين سدادة صمام موجهة ذات سفر طويل، وغشاء مدعوم محيطياً، وغشاء قابل للاستبدال، ومانع تسرب للصمام.
- الجسم - يلبي جسم من النايلون المملوء بالزجاج متطلبات الصيانة الصارمة.
- يوفر التصميم الشامل «الشفاف» والمقعد كامل التجويف مسار تدفق خالٍ من العوائق أو أقفاص الدعم أو الأعمدة، مما يتيح سعة تدفق فائقة مع أدنى حد من فقدان الضغط.

الميزات والفوائد الرئيسية

- محبس صناعي متين، مصمم ومُصنَّع من نايلون مملوء بالزجاج ليتحمل ظروف التشغيل القاسية.
- سعة تدفق فائقة مع أدنى حد من فقدان الضغط.
- مُصمم للخدمة في نطاق واسع من ظروف الضغط والتدفق، من التدفق المتقطر إلى التدفق الأقصى.
- تصميم بسيط بقطع قليلة يضمن سهولة الفحص والصيانة داخل الخط.
- يوفر ختم الصمام الموجه إيجابياً حركة دقيقة وتنظيماً سلساً. أو ذو حواف.
- وصلات مفصلية ذات حواف تعزل الصمام عن انحناء الخط وإجهادات الضغط.
- تنظيم دقيق ومستقر مع حركة سلسة.
- متطلبات ضغط تشغيل منخفضة.
- لا يتعرض الغشاء للتآكل أو التشويه.
- يلبي الغشاء والزنبرك متطلبات نطاق ضغط تشغيل المحبس بالكامل.
- يُنتج التدفق المباشر سعة تدفق فائقة مع أدنى حد من فقدان الضغط.





محابس التحكم الهيدروليكية البلاستيكية عالية الأداء من AMA يُنصح باستخدام محابس التحكم الهيدروليكية AMI لتطبيقات الري والعشب. فهي مصنوعة بالكامل من بلاستيك متين، وتتميز بأحدث تقنيات البلاستيك، مما يوفر أداءً هيدروليكيًا منخفض الاحتكاك ومُبطّنًا بالتدفق. تعمل محابس AMI بغشاء مُقوّى، مما يُغني عن استخدام زنبرك معدني. يسمح التصميم المرن الخاص للوصام بالفتح والإغلاق تدريجيًا وبدقة، مما يجعله مثاليًا لأغراض التنظيم. بفضل الاستغناء عن الزنبرك المعدني، لا يتطلب محبس AMI أي صيانة تقريبًا.

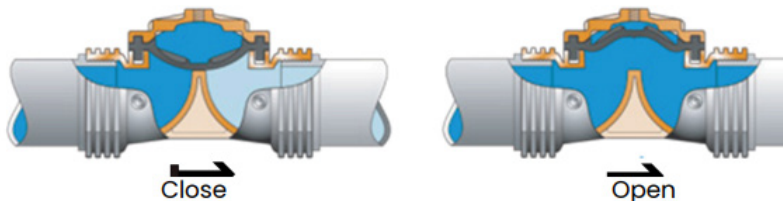

Dimensions
2 °F BSPT
3°F BSPT
3" Flange
4" Flange

- الغطاء - هيكل الغطاء الفريد والمتين مصنوع من النايلون المقوى بالزجاج.
- الغشاء - يضمن الغشاء «بدون زنبرك» توزيعًا متساويًا للضغط على منطقة الختم، ويمنع التشوه، ويضمن تشغيلًا أطول دون صيانة.
- الهيكل - صمام جسري ذو تدفق مستقيم مصنوع من النايلون المقوى بالزجاج.
- المثبتات - صواميل فولاذية ذاتية القفل مطلية بالكروم ومسامير سداسية من الفولاذ المقاوم للصدأ تسهل الوصول وتمنع التآكل.

مخطط انسيابي للمواصفات الفنية

	2"	3"	4"
Available connections	Threaded	●	●
	Flanged		●
Flow range(m ³ /h)	10-40	20-70	50-110
Minimum operating Pressure(Bar/PSI)	1.3-0.5 / 5-7		
Maximum operating Pressure(Bar/PSI)	10 / 145		
Maximum water temperature(°C/F)	70 / 180		

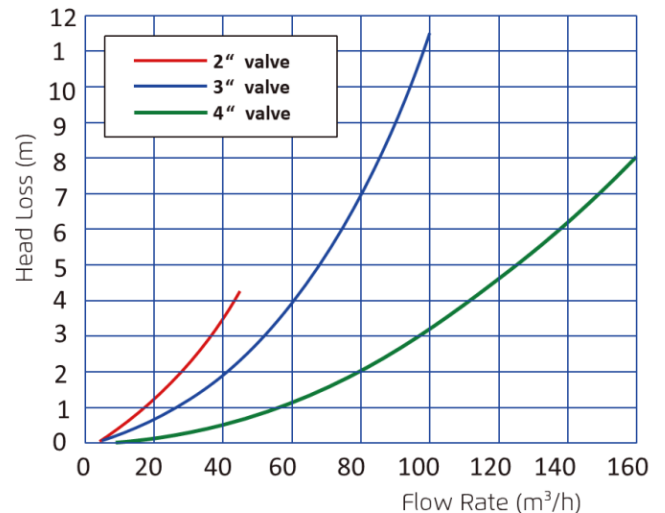

محبس تحكم كهربائي

(AC/DC-24V, Pulse 1224-V)



Dimensions	PN
2 °F	10
2-1/2 °F	10
3 °F	10
3" Flange	10
3"L Flange	10
4" Flange	10

محبس تحكم يدوي



Dimensions	PN
2 °F	10
2-1/2 °F	10
3 °F	10
3" Flange	10
3"L Flange	10
4" Flange	10

محبس تخفيض الضغط الكهربائي

(AC/DC-24V, Pulse 1224-V)



Dimensions	PN
2 °F	10
2-1/2 °F	10
3 °F	10
3" Flange	10
3"L Flange	10
4" Flange	10

محبس تخفيض الضغط اليدوي



Dimensions	PN
2 °F	10
2-1/2 °F	10
3 °F	10
3" Flange	10
3"L Flange	10
4" Flange	10

محبس كهربائي للحفاظ علي الضغط

(AC/DC-24V, Pulse 1224-V)



Dimensions	PN
2 °F	10
2-1/2 °F	10
3 °F	10
3" Flange	10
3"L Flange	10
4" Flange	10

محبس الحفاظ علي الضغط



Dimensions	PN
2 °F	10
2-1/2 °F	10
3 °F	10
3" Flange	10
3"L Flange	10
4" Flange	10

محبس كهربائي للحفاظ علي الضغط

(AC/DC-24V, Pulse 1224-V)



Dimensions	PN
1"F	10
2"F	10

محبس تحكم يدوي



Dimensions	PN
2 °F	10

محبس تخفيض الضغط الكهربائي

(AC/DC-24V, Pulse 1224-V)



Dimensions	PN
2 °F	10

محبس كهربائي للحفاظ علي الضغط

(AC/DC-24V, Pulse 1224-V)



Dimensions	PN
2 °F	10

محبس كهربائي للحفاظ علي الضغط بفلنجة

(AC/DC-24V, Pulse 1224-V)



Dimensions	PN
2"F	10
3"F	10
3" Flange	10
4" Flange	10
5" Flange	10
6" Flange	10

محبس كهربائي

(AC/DC-24V, Pulse 1224-V)



Dimensions	PN
2"F	10
3"F	10
3" Flange	10
4" Flange	10
5" Flange	10
6" Flange	10

محبس كهربائي للحفاظ علي الضغط

(AC/DC-24V, Pulse 1224-V)

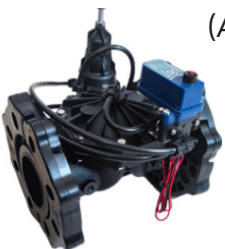

Dimensions	PN
2"F	10
3"F	10
3" Flange	10
4" Flange	10
5" Flange	10
6" Flange	10

محبس تخفيض الضغط اليدوي



Dimensions	PN
2 °F	10

محبس يدوي للحفاظ علي الضغط



Dimensions	PN
2 °F	10

محبس يدوي للحفاظ علي الضغط بفلنجة



Dimensions	PN
2"F	10
3"F	10
3" Flange	10
4" Flange	10
5" Flange	10
6" Flange	10

محبس تحكم يدوي



Dimensions	PN
2"F	10
3"F	10
3" Flange	10
4" Flange	10
5" Flange	10
6" Flange	10

محبس يدوي للحفاظ علي الضغط بفلنجة



Dimensions	PN
2"F	10
3"F	10
3" Flange	10
4" Flange	10
5" Flange	10
6" Flange	10

محبس أساس AMA



Dimensions	PN
2"F	10
2-1/2"F	10
3"F	
3" Flange	10
3"L Flange	10
4" Flange	10

محبس أساسي ADI



Dimensions	PN
2"F	10

محبس أساسي AMI



Dimensions	PN
2"F	10
3"F	10
3" Flange	10
4" Flange	10
5" Flange	10
6" Flange	10

لوحة تحكم الكتروني



SIZE	M1	M2	BATTERY	ELECTRICALLY
1	HUNTER	/	✓	⊗
2	HUNTER	RAIN BIRD	✓	✓
4	HUNTER	RAIN BIRD	⊗	✓
6	HUNTER	RAIN BIRD	⊗	✓
8	HUNTER	/	⊗	✓
24	/	RAIN BIRD	⊗	✓

محابس PVC

محبس PVC سن خارجي

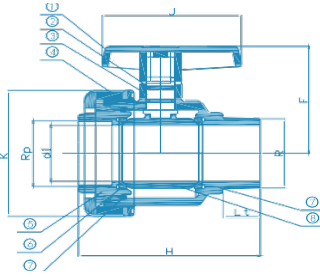

SIZE	DN	LT	H	F	J	K	d1
3/4"×3/4"	20	16	80	58	65	59	19
1"×1"	25	17	90	67	75	67	23
1-1/4"×1-1/4"	32	21	106	76	85	79	32
1-1/2"×1-1/2"	40	24	126	83	94	93	39
2"×2"	50	26	145	101	109	114	46
2-1/2"×2-1/2"	65	28	177	127	138	144	64
3"×3"	80	35	204	143	158	168	76
4"×4"	100	37	250	169	180	210	97

محبس PVC سن داخلي

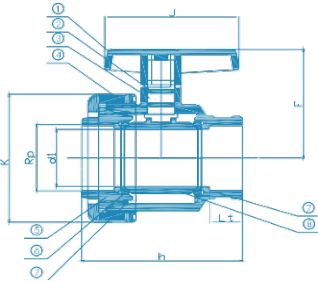

SIZE	DN	LT	H	F	J	K	d1
3/4"×3/4"	20	20	81	58	65	59	19
1"×1"	25	22	91	67	75	67	23
1-1/4"×1-1/4"	32	25	101	76	85	79	32
1-1/2"×1-1/2"	40	25	109	83	94	93	39
2"×2"	50	29	135	101	109	114	46
2-1/2"×2-1/2"	65	36	177	127	138	144	64
3"×3"	80	36	180	143	158	168	76
4"×4"	100	49	228	169	180	210	97

محبس PVC سن خارجي

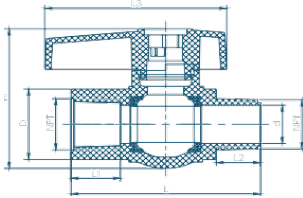
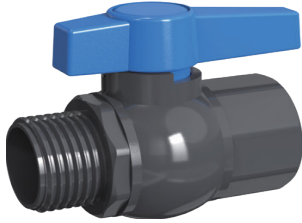

SIZE	d	D2	L	L1	L2	L3	H	NPT
1/2"	15.6	28.8	69	69	16.1	66.3	57	1/2"
3/4"	21	34.5	80	80	18	79.7	67.6	3/4"
1"	26.8	42.1	93.3	25.3	23	89.7	79.3	1"
1-1/4"	33.5	52.1	107	27	25.5	101.4	91.7	1-1/4"
1-1/2"	39.5	59.5	123.7	30	28	117.7	101.8	1-1/2"
2"	50	72.3	151	35	30	135.1	122.64	2"

محبس PVC

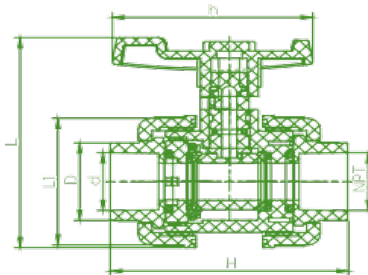

SIZE	THD./in	THD./in2	d1	BS d	ANSI d	DIN da	D	d2	L	L1	H	h2
15mm(1/2")	14	14	22	22	21.34	20	29	21.7	78.8	47.5	78.6	66.2
20mm(3/4")	14	14	26	26	26.67	25	35	27.2	88.8	58.1	88.4	76.2
25mm(1")	11.5	11	32	34	33.4	32	42.9	32.4	100.6	65.5	101.6	86.8
32mm(1-1/4")	11.5	11	38	42	42.16	40	52	40.4	127.2	80	128.2	109.9
40mm(1-1/2")	11.5	11	48	48	48.26	50	62	48	136.1	91.1	142.2	136.1
50mm(2")	11.5	11	60	60	60.33	63	57.7	60.5	160.6	112.1	168.5	144.9
65mm(2-1/2")	8	11	76	76	73.03	75	87.7	75.5	200	135.6	217	181.7
80mm(3")	8	11	89	89	88.9	90	105.7	90.5	228.3	163	242	207.3
100mm(4")	8	11	114	114	114.3	110	75.5	60.5	160.6	112.1	168.5	144.9

محبس اختبار

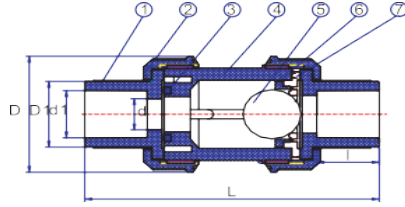

SIZE	THD./in n	THD./in n2	JIS d1	BS d	ANSI d	DIN da	d1	D1	D	I	L
15mm(1/2")	14	14	22	22	21.34	20	15	27.5	51.3	20.5	105
20mm(3/4")	14	14	26	26	26.67	25	19.5	35	65.5	25	116.5
25mm(1")	11.5	11	32	34	33.4	32	25	41.6	73.7	28	130.5
32mm(1-1/4")	11.5	11	38	42	42.16	40	32	51.6	86.8	29.5	148.5
40mm(1-1/2")	11.5	11	48	48	48.26	50	40	60.9	102	34	168.5
50mm(2")	11.5	11	60	60	60.33	63	50	75	119.8	40	189

شفاط PVC

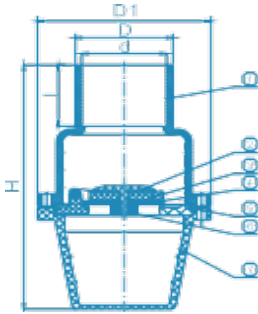

SIZE	THD./in	THD./in2	d1	BS d	ANSI d	DIN d	D	d2	I	L
15mm(1/2")	14	14	22	22	21.34	20	31	43.7	31	137
20mm(3/4")	14	14	26	26	26.67	25	35.5	43.7	32.5	141
25mm(1")	11.5	11	32	34	33.4	32	41.9	43.7	32.8	141
32mm(1-1/4")	11.5	11	38	42	42.16	40	51	78	35	195
40mm(1-1/2")	11.5	11	48	48	48.26	50	60.3	78	56.2	217.4
50mm(2")	11.5	11	60	60	60.33	63	72.5	78	57	214.4
75mm(2-1/2")	8	11	76	76	73.03	75	90	171.6	73.5	293.4
90mm(3")	8	11	89	89	88.9	90	76.4	183.8	58.2	252
110mm(4")	8	11	114	114	114.3	110	115	216	91	360
125mm	/	/	/	/	/	125.6	142.5	232.6	95	368.47
140mm	/	/	/	/	/	159	159	246.5	105	430
160mm(6")	8	11	165	168.5	168.3	161	161	291	120	500

محبس فراشة بلاستيك

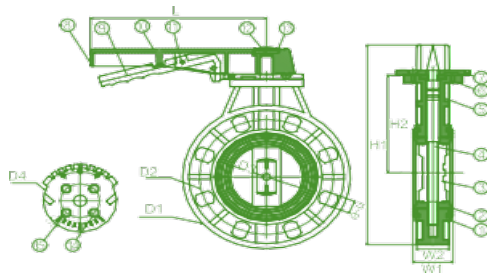

SIZE	JIS d1	ANSI d	DIN da	D1	D3	D4	L	H1	H2	W1	W2	DIN n-oe	JIS n-oe2
50mm(2")	22	21.34	20	160.1	55.6	99.7	189.7	223.3	98.3	44	32	4~20	4~19
65MM(2-1/2")	26	26.67	25	179.8	68.7	99.7	189	247	116.6	84.3	32.4	4~18	4~19
80mm(3")	32	33.4	32	195	83.9	99.7	238.5	282.6	132.5	51.9	36.3	8~20	4~19
100mm(4")	38	42.16	40	228.1	103.2	99.7	239.5	319.4	155.4	54.5	44.1	8~20	8~19
125mm(5")	48	48.26	50	257	129.5	139	309.8	368	170.3	66.5	54.6	8~21.5	8~19
150mm(6")	60	60.33	63	285.4	151.1	140	309.8	400.8	187.5	73.1	56.4	8~24	8~23
200mm(8")	/	/	/	342.6	198.6	140	309.8	473	230	92	72.2	8~25	12~23

محبس فراشة بفلنجة

SIZE	FLANGA	D	L1	BOLT QTY
50*2"	63	160	43	4
65*2-1/2"	75	180	46	4
80*3"	90	196	49	8
100*4"	110	228	54	8
125*5"	125,140	258	64	8
150*6"	160	287	70	8
200*8"	200,225	344	88	8
150*10"	250,280	412	98	12
300*12"	315	460	180	12
350*14"	350	500	88	16
400*16"	400	565	96	16

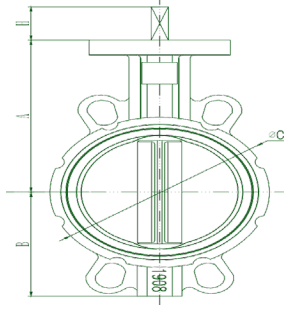
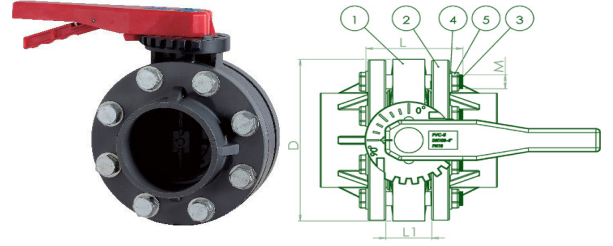

محبس فراشة

SIZE	A	B	C	D	LO	H	1ISO521	L	K	E	D1
50mm	161	80	43	52.9	266	9	F07	42	90	70	120.6
65mm	175	89	46	64.5	266	9	F07	44.7	90	70	139.7
80mm	181	95	46	78.8	266	9	F07	45.2	90	70	152.4
100mm	200	114	52	101	266	11	F07	52.1	90	70	190.5
125mm	213	127	56	123.3	266	14	F07	54.4	90	70	215.9
150mm	226	139	56	155.1	266	14	F07	55.8	90	70	241.3
200mm	260	175	60	202.5	355	17	F010	60.6	125	102	298.4
250mm	292	203	68	250.5	355	22	F10	65.6	125	102	361.9
300mm	337	212	78	301.6	355	22	F12	76.9	150	125	431.8



محبس هواء

D"	PN	Kg/Box	Box Type
2" BSPT Kinetic	10	10.24	0.045
2" BSPT Combination	10	10.32	0.045
1.5" BSPT Kinetic	10	10.24	0.045
1.5" BSPT Combination	10	10.32	0.045
1" BSPT Kinetic	10	10.24	0.045
1" BSPT Combination	10	10.32	0.045

صندوق محبس

صندوق محبس دائري ١٠ بوصة



SPEC	10"
BOTTOM DIAM	330mm
HIGH	260mm
TOP	254mm

صندوق محبس ٦ بوصة



SPEC	6"
BOTTOM DIAM	205mm
HIGH	230mm
TOP	160mm

صندوق محبس ١٤ بوصة



SPEC	14"
BOTTOM DIAM	665*495mm
HIGH	335mm
TOP	555*395mm

صندوق محبس ١٢ بوصة



SPEC	12"
BOTTOM DIAM	535*400mm
HIGH	335mm
TOP	435*300mm

فلتر زراعي

فلتر تي اسكرين

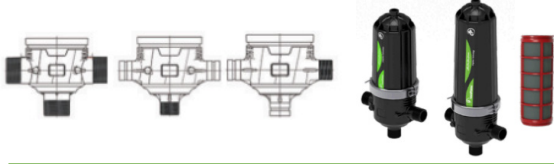

SIZE	m ³ /h (120mesh)	Pcs/Box	Kg/Box	CBM/BOX
2"	30	1	6.5	0.0544
2" Long	40	1	7	0.0648
2-1/2"	30	1	6.5	0.0544
2-1/2" Long	40	1	7.5	0.0648
3" Short	50	1	6.5	0.0594
3"	50	1	7.5	0.0648

فلتر مزدوج ديسك

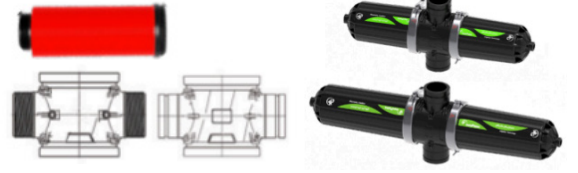

SIZE	m ³ /h (120mesh)	Pcs/Box	Kg/Box
3"	60	1	12
3" Long	100	1	15
4"	70	1	12.5
4" Long	100	1	15

فلتر مزدوج اسكرين



SIZE	m ³ /h (120mesh h)	Pcs/Box	Kg/Box	CBM/BOX
3"	60	1	9.5	0.0829
3" Long	100	1	11	0.1037
4"	70	1	9.5	0.0829
4" Long	100	1	11	0.1037

فلتر واي اسكرين



SIZE	m ³ /h (120mesh)	Pcs/Box	Kg/Box
3/4"	5	50	-
1"	10	50	-
1-1/4"	15	16	-
1-1/2"	16	16	-
2"	25	10	-

فلتر زوجي اتوماتيك



SIZE	m ³ /h (120mes h)	Pcs/Box	Kg/Box	CBM/BOX
3"	50	1	17	0.1037
4"	60	1	17	0.1037

فلتر زراعي اسكرين



SIZE	m ³ /h (120mesh)	Pcs/Box	Kg/Box	CBM/BOX
2"	-	1	-	-
2" Flange	-	1	-	-
3"	-	1	-	-
3" Flange	-	1	-	-

فلتر هيدروليكي



SIZE	m ³ /h	Pcs/Box	Kg/Box	CBM/BOX X
2" Flange	40	1 pcs x 2 box	-	-
3" Flange	50	1 pcs x 2 box	18.5	-
4" Flange	100	1 pcs x 2 box	30.5	-

لوحة فلتر اتوماتيك



Specification	Kg/Box	CBM
2pcs * 2" filter + 3" Manifolds	-	-
3pcs * 2" filter + 4" Manifolds	-	-
3pcs * 2" filter + 4" Manifolds	-	-
4pcs * 2" filter + 4" Manifolds	-	-
3pcs * 3" filter + 4" Manifolds	-	-
4pcs * 3" filter + 6" Manifolds	-	-
5pcs * 3" filter + 6" Manifolds	-	-
5pcs * 3" filter + 6" Manifolds	-	-
6pcs * 3" filter + 6" Manifolds	-	-
5pcs * 4" filter + 8" Manifolds	-	-
4pcs * 4" filter + 8" Manifolds	-	-
5pcs * 4" filter + 8" Manifolds	-	-
6pcs * 4" filter + 8" Manifolds	-	-
7pcs * 4" filter + 10" Manifolds	-	-
8pcs * 4" filter + 10" Manifolds	-	-
9pcs * 4" filter + 10" Manifolds	-	-
10pcs * 4" filter + 12" Manifolds	-	-

فلتر غسيل اتوماتيك



SIZE	m ³ /h (120mesh)	Pcs/Box	Kg/Box	CBM/BOX
3"	-	1	-	-
4"	-	1	-	-
3"	-	1	-	-
4"	-	1	-	-
4"	-	1	-	-

التنقيط والرشاشات

DESCRIPTION	SIZE
PUNCH FOR OFFTAKE FOR PIPE	16
	20
DRIPPER PUNCH	Metal Head
DRIPPER PUNCH	Metal Head
PUNCH FOR OFFTAKE FOR PIPE WITH DRILL	20



خرامة

نقاط قابل للتعديل



نقاط برميلي

L/H	Pcs/Bag	Pcs/Box	Kg/Box	Box Type
16	100	900	10	A



Type	L/H	Pcs/Bag	Pcs/Box	Kg/Box	Box Type
A	0-70	700	7000	14.45	A
B	0-135	300	3300	14.4	A
C	0-150	100	3200	-	A



سدة نقاط

A

B

L/H	Pcs/Bag	Pcs/Box	Kg/Box	Box Type
10-260	200	9000	20.07	A

نقاط اسود



L/H

0-220

رشاش ميكرو 360

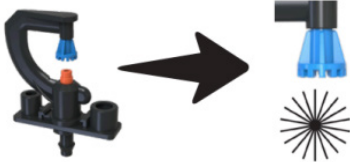

L/H	Box Type
4*7-60 L/H	A

نقاط ازرق



رشاش

رشاش ميكرو بنزل نحاسي

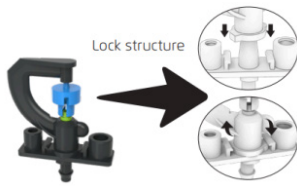

Use for 5*8 micro tube ID: DIN 20& ANSI 21.3 mm

TYPE	L/H
A	55
A	95
A	150
B	55
B	95
B	150
A	175
B	75

SIZE	Pcs /Bag	Pcs /Box	Kg /Box	Box Type
47°-60 L/H	200	2200	14.76	A
47°-130 L/H	200	2200	15.05	A

ببلر أصول



360°

SIZE	Pcs /Bag	Pcs /Box	Kg /Box	Box Type
1/2"	200	1400	-	A



رشاشات

SIZE	MARKA	MARKA2	MARKA3
1/2"	HUNTER	RAIN BIRD	OSOOL
3/4"	HUNTER	RAIN BIRD	/
1/2" LONG	HUNTER	/	OSOOL

محبس نحاسي حديقة



SPEC	G3/4"
MAX PRESSURE	8.2bar

محبس نحاسي حديقة



SPEC	G1"
MAX PRESSURE	8.2bar

استيك بابلر



Type	D"	Pcs/Bag	Pcs/Box
A	1/2" M	40	280
A	3/4" M	-	-
A	1/2" F x 3/4" M	40	280
B	1/2"-16cm	200	1400



رشاش ميكرو فراشة



Type	D"	Pcs/Bag	Pcs/Box	Kg/Box	Box Type
A	1/2" F x 3/4" F	30	900	9.05	A
A	1/2" F x 3/4" F	30	900	9.05	A
B	1/2" M x 3/4" M	30	1050	10.62	A
B	1/2" M x 3/4" M	30	1050	10.62	A

رشاش تحكم



Nozzle:



TYPE	D"	Pcs/Box	Pcs/Bag	Kg/Box	Box Type
A	1/2" M	1	250	-	A
B	1/2" M	1	250	12.50	A

رشاش ٤ ملي

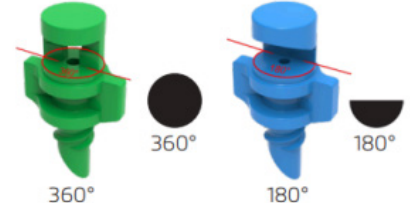

φ	L/H	Pcs/Bag	Pcs/Box	Kg/Box	Box Type
180°	45 l/h	1000	36000	24.45	A
180°	120 l/h	1000	36000	24.45	A
360°	45 l/h	1000	36000	22.80	A
360°	120 l/h	1000	36000	22.80	A

رشاش دائري



L/H	Pcs/Bag	Pcs/Box	Kg/Box	Box Type
100-180	200	1400	13.84	A

رشاش برتقالي



D"	Pcs/Box	Pcs/Bag	Kg/Box	Box Type
3/4" F	50	1	-	A
1" F	50	1	10.87	A

رشاش اسود بزل نحاسي



D"	Pcs/Box	Pcs/Bag	Kg/Box	Box Type
3/4" M	100	1	15.79	A

رشاش تحكم بنزل متعدد



Nozzle:



D"	Pcs/Box	Pcs/Bag	Kg/Box	Box Type
1/2" M	140	1	-	A

رشاش تحكم عادي اسود



D"	Pcs/Box	Pcs/Bag	Kg/Box	Box Type
3/4" M	100	1	13.25	A

رشاش بنزل متعدد



Nozzle:



D"	Pcs/Box	Pcs/Bag	Kg/Box	Box Type
100	1	13.25	A	

رشاش ميكرو بنزل نحاسي



360°

L/H	Pcs/Box	Pcs/Bag	Kg/Box	Box Type
23-33	-	-	-	A
38-55	-	-	-	A
54-79	-	-	-	A
73-107	-	-	-	A
90-125	-	-	-	A
116-162	-	-	-	A
148-221	-	-	-	A



360°

L/H	Pcs/Box	Pcs/Bag	Kg/Box	Box Type
23-33	-	-	-	A
38-55	-	-	-	A
54-79	-	-	-	A
73-107	-	-	-	A
90-125	-	-	-	A
116-162	-	-	-	A
148-221	-	-	-	A

رشاش ميكرو

سدة



ø	Pcs/Bag	Pcs/Box	Kg/Box	Box Type
8mm	-	-	-	A

نقاص



Use for Pop-Up Sprinkler

D" * D"	Pcs/Bag	Pcs/Box	Kg/Box	Box Type
3/8" M * 1/2" F	300	3000	15.03	A

رشاش رامبو



360°

180°

A

B

TYPE	D"	L/H	Pcs/Bag	Pcs/Box	Kg/Box	Box Type
A	1/2"	240 L/H	10	-	11.32	A
A	1/2"	350 L/H	10	-	11.32	A
A	1/2"	450 L/H	10	-	11.32	A

رشاش متعدد الدفع



angel 24°



Reflector

D"	L/H	Pcs/Bag	Pcs/Box	Kg/Box	Box Type
1/2"	250 L/H	10	-	-	A
1/2"	350 L/H	10	-	-	A
1/2"	450 L/H	10	-	-	A
1/2"	550 L/H	10	-	-	A
1/2"	650 L/H	10	-	-	A

رشاش محوري

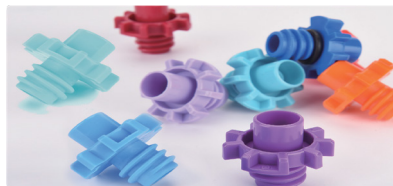

SIZE	PRESSURE	RANGE	FLOW	NOZZLE SIZE
G3/4"	1.0-3.0BAR	4-6M	0.7-1.1M3/H	5-26MM

SIZE	QUANTITY	G.W/N.W	MATERIAL
45*35*39.5CM	200PCS	12/11KGS	PP

رشاش حديقة

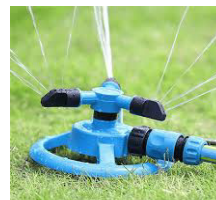

قطع ري الكبس

محبس فراشة كبس



∅*∅	Pcs/Bag	Pcs/Box	Kg/Box	Box Type
16*16	50	750	11.28	A
20*20	50	600	11.25	A
16*20	-	-	-	A

محبس فراشة سنة



∅*∅	Pcs/Bag	Pcs/Box	Kg/Box	Box Type
16*1/2"	50	600	9.80	A
16*3/4"	50	500	8.96	A
20*1/2"	-	-	-	A
20*3/4"	-	-	-	A

محبس دائري سنة



∅*∅	Pcs/Bag	Pcs/Box	Kg/Box	Box Type
20*3/4"	10	-	-	A

محبس دائري كبس



∅*∅	Pcs/Bag	Pcs/Box	Kg/Box	Box Type
20*20	-	-	-	A

محبس GR سنة



∅*∅	Pcs/Bag	Pcs/Box	Kg/Box	Box Type
25*3/4"	10	1200	-	A
25*1"	-	-	-	A
32*3/4"	-	-	-	A
32*1"	-	-	-	A

محبس GR كبس



∅*∅	Pcs/Bag	Pcs/Box	Kg/Box	Box Type
25*25	10	120	-	A
32*32	10	110	-	A



محبس GR
(DN: 17.6mm)



محبس موسمي
(DN: 12.8mm)



محبس دائري
(DN: 9.5mm)



محبس فراشة
(DN: 9.5mm)



محبس فراشة
(DN: 9.5mm)

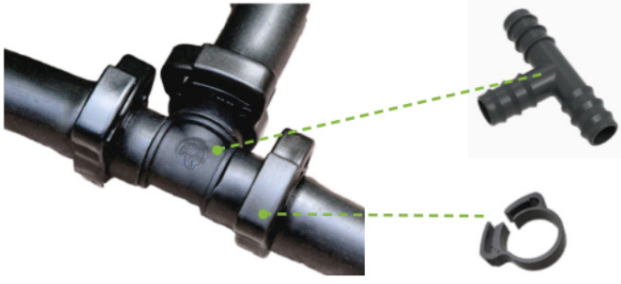

فيتنج الكبس المصنوعه من مادة البولي بروبيلين

- سهل التركيب، مما يقلل من الوقت والتكلفة أثناء عملية التثبيت.
- يجب أن يحتوي على سنون قابلة للانطواء لمنع الانفلات وتقليل تلف الجزء الداخلي (الجروميت) أثناء عملية التثبيت.

وصلة كبس ميكرو



3*5 4*7 4*7 4*7 4*7 6*9

∅*∅	Pcs/Bag	Pcs/Box	Kg/Box	Box Type
5*5	2000	30000	-	A
6*6	1000	25000	12.68	A
Thread 6*6	-	-	-	A
Thread 6*6	-	-	-	A
6*6	1000	40000	15.19	A
8*8	250	10016	16.8	A

وصلة نقاص كبس



TYPE	∅*∅	Pcs/Bag	Pcs/Box	Kg/Box	Box Type
A	11*16	500	5000	13.66	B
B	16*16	300	3600	14.07	B
C	16*20	100	3000	-	B
D	20*20	200	3000	-	B

قسام ٧ كبس



∅*∅	Pcs/Bag	Pcs/Box	Kg/Box	Box Type
16*16	100	1200	8.85	A

قسام تي كبس



∅*∅*∅	Pcs/Bag	Pcs/Box	Kg/Box	Box Type
16*16*16	100	1500	10.47	B
20*20*20	50	1100	10.39	B
16*20*16	100	1300	11.12	A
20*16*20	-	-	-	-
20*25*20	50	900	9.73	B
25*20*25	50	-	-	-
25*25*25	50	600	8.97	B
32*32*32	-	-	-	-

كوع كبس



∅*∅	Pcs/Bag	Pcs/Box	Kg/Box	Box Type
16*16	100	1800	12.02	A
20*20	100	1200	12.67	B
25*25	50	800	9.12	B
32*32	-	-	-	B

وصلة كبس



∅*∅	Pcs/Bag	Pcs/Box	Kg/Box	Box Type
16*16	200	3600	14.25	B
20*20	200	2400	10.60	B
25*25	-	-	-	B
32*32	-	-	-	B
16*20	200	2000	8.50	A

بداية كبس



∅*D"	Pcs/Bag	Pcs/Box	Kg/Box	Box Type
16*1/2"M	100	1600	11.37	B
16*3/4"M	100	1800	16.12	B
20*1/2"M	100	1400	14.65	B
20*3/4"M	100	1300	13.76	B
25*3/4"M	100	1100	11.94	B
25*1"M	-	-	-	B
32*1"M	25	600	14.13	B



قسام كبس بسن

D"*∅	Pcs/Bag	Pcs/Box	Kg/Box	Box Type
1/2"*1616	100	1000	8.29	A
3/4"*1616	100	800	8.16	A
1/2"*2020	50	700	8.71	A
3/4"*2020	50	500	7.02	A
1/2"*2525	50	450	7.21	A
3/4"*2525	-	-	-	A
1"*2525	-	-	-	A
3/4"*3232	-	-	-	A
1"*3232	-	-	-	A



كوع كبس بسن

D*∅	Pcs/Bag	Pcs/Box	Kg/Box	Box Type
1/2"*16	100	1500	-	A
3/4"*16	100	1000	-	A
1/2"*20	50	800	-	A
3/4"*20	100	800	-	A
1/2"*25	-	-	-	A
3/4"*25	-	-	-	A
1"*25	-	-	-	A
1"*32	-	-	-	A



ربل كقر

∅	Pcs/Bag	Pcs/Box	Kg/Box	Box Type
11	200	13000	12.72	A



كقر 16

∅	Pcs/Bag	Pcs/Box	Kg/Box	Box Type
16	500	5000	13.08	A



سدة ربل

∅	Pcs/Bag	Pcs/Box	Kg/Box	Box Type
16	100	4000	13.42	A



كقر اسود

∅	Pcs/Bag	Pcs/Box	Kg/Box	Box Type
14	800	8000	13.66	A
16	1000	5000	12.26	A



كوع كبس بسن

∅*∅	Pcs/Bag	Pcs/Box	Kg/Box	Box Type
17*1/2"	-	-	-	-
17*3/4"	-	-	-	-



ربل كقر

∅	Pcs/Bag	Pcs/Box	Kg/Box	Box Type
14	700	7000	14.71	A
16	500	5000	16.00	A
20	300	3300	12.74	A
22	-	-	-	A



قسام بسن

∅∅	Pcs/Bag	Pcs/Box	Kg/Box	Box Type
17*17*1/2"	25	1000	9.85	A
17*17*3/4"	25	900	10.38	A



كوع كبس

∅*∅	Pcs/Bag	Pcs/Box	Kg/Box	Box Type
17*17	100	2000	10.30	A



قسام كبس

∅*∅*∅	Pcs/Bag	Pcs/Box	Kg/Box	Box Type
17*17*17	25	1000	8.43	A



بداية كبس

D"	Pcs/Bag	Pcs/Box	Kg/Box	Box Type
16*1/2"				
16*3/4"				



كوع كبس بسن

D"	Pcs/Bag	Pcs/Box	Kg/Box	Box Type
16*1/2"	100	1000	11.77	A
16*3/4"	100	900	13.07	A



بداية كبس بني

∅*∅	Pcs/Bag	Pcs/Box	Kg/Box	Box Type
17*1/2"	-	-	-	-
17*3/4"	-	-	-	-



بداية كبس موسمي

∅*∅	Pcs/Bag	Pcs/Box	Kg/Box	Box Type
17**1/2"	100	1000	11.68	A
17**3/4"	100	1000	13.10	A



وصلة كبس

∅*∅	Pcs/Bag	Pcs/Box	Kg/Box	Box Type
17*17	100	2400	11.68	A



قسام كبس موسمي

∅*∅*∅	Pcs/Bag	Pcs/Box	Kg/Box	Box Type
17*17*17	-	-	-	-



وصلة كبس موسمي

∅*∅	Pcs/Bag	Pcs/Box	Kg/Box	Box Type
16*17	100	1500	10.75	A



كوع كبس سن موسمي

∅*∅	Pcs/Bag	Pcs/Box	Kg/Box	Box Type
17**1/2"	100	700	9.21	A
17**3/4"	100	600	8.79	A



وصلة كبس موسمي

∅*∅	Pcs/Bag	Pcs/Box	Kg/Box	Box Type
17*17	50	800	10.65	A
20*20	50	400	11.30	A
22*22	50	400	11.90	A



كوع كبس سن موسمي

∅*∅	Pcs/Bag	Pcs/Box	Kg/Box	Box Type
17**1/2"				
17**3/4"				



وصلة كبس موسمي

∅*∅	Pcs/Bag	Pcs/Box	Kg/Box	Box Type
17*17	100	1100	9.72	A



كوع نقاص كبس موسمي

∅	Pcs/Bag	Pcs/Box	Kg/Box	Box Type
17*16	50	600	9.82	A



وصلة نقاص موسمي

∅	Pcs/Bag	Pcs/Box	Kg/Box	Box Type
14*17	100	1100	11.74	A



قسام واي كبس موسمي

∅*∅*∅	Pcs/Bag	Pcs/Box	Kg/Box	Box Type
17*17*16	-	-	-	A



قسام كبس موسمي

∅*∅	Pcs/Bag	Pcs/Box	Kg/Box	Box Type
17	-	-	-	-



وصلة نقاص كبس موسمي

∅*∅	Pcs/Bag	Pcs/Box	Kg/Box	Box Type
16*17	100	1000	10.36	A
16*20	-	-	-	A
16*22	-	-	-	A
20*20	-	-	-	A
20*22	-	-	-	A



كوع كبس موسمي

∅*∅	Pcs/Bag	Pcs/Box	Kg/Box	Box Type
17*17	50	600	9.82	A



قسام تي كبس موسمي بسن خارجي

∅*∅*∅	Pcs/Bag	Pcs/Box	Kg/Box	Box Type
17*17*1/2"	50	400	9.25	A
17*17*3/4"	-	-	-	-



قسام تي كبس موسمي بسن خارجي

∅*∅*∅	Pcs/Bag	Pcs/Box	Kg/Box	Box Type
17*17*1/2"	-	-	-	-
17*17*3/4"	-	-	-	-



قسام كبس موسمي الطرف

∅*∅*∅	Pcs/Bag	Pcs/Box	Kg/Box	Box Type
16*16*17	-	-	-	A



قسام تي كبس موسمي

∅*∅*∅	Pcs/Bag	Pcs/Box	Kg/Box	Box Type
17*17*17	50	350	8.50	A



قسام تي كبس موسمي

∅*∅*∅	Pcs/Bag	Pcs/Box	Kg/Box	Box Type
17*17*16	50	400	8.04	A



قسام تي كبس موسمي

∅*∅*∅	Pcs/Bag	Pcs/Box	Kg/Box	Box Type
17*17*16	-	-	-	-



قسام تي كبس موسمي

∅*∅	Pcs/Bag	Pcs/Box	Kg/Box	Box Type
17	25	250	9.11	A



سدة

∅	Pcs/Bag	Pcs/Box	Kg/Box	Box Type
16	100	6000	-	A
20	100	3000	14.33	A
25	-	-	-	A



سدة انثى

TYPE	D"	Pcs/Bag	Pcs/Box	Kg/Box
A	3/8"	350	3500	12.06
B	3/8"	200	2000	13.93



سدة سن خارجي



مخرج فرعي مع السدة



سدة كبس

∅	Pcs/Bag	Pcs/Box	Kg/Box	Box Type
15	100	6000	18.55	A



نهاية طرف لي

∅	Pcs/Bag	Pcs/Box	Kg/Box	Box Type
16	100	2700	8.93	A
20	100	1600	8.07	A

فنشوري

فنشوري (PP)



BSPT	Pcs/Bag	Pcs/Box	Kg/Box	Box Type
2"	1	6	13.65	B

فنشوري (POM)



BSPT	Pcs/Bag	Pcs/Box	Kg/Box	Box Type
1/2"	-	50	11.39	B

فنشوري (POM)



BSPT	Pcs/Bag	Pcs/Box	Kg/Box	Box Type
3/4"	-	50	11.02	B

فنشوري (PP)



BSPT	Pcs/Bag	Pcs/Box	Kg/Box	Box Type
3"	1	3	13.08	B

فنشوري (PP)



BSPT	Pcs/Bag	Pcs/Box	Kg/Box	Box Type
1"	1	20	15.58	B
1-1/2"	1	15	12.28	B

رشاش مدفعي



رشاش مدفعي

D"	Pcs/Bag	Pcs/Box	Kg/Box	Box Type
2" F	-	-	-	B



رشاش مدفعي

D"	Pcs/Bag	Pcs/Box	Kg/Box	Box Type
1" F	4	28	21.52	B



رشاش مدفعي -24°

D"	Pcs/Bag	Pcs/Box	Kg/Box	Box Type
1-1/2" F	-	-	-	B



رشاش مدفعي

D"	Pcs/Bag	Pcs/Box	Kg/Box	Box Type
1-1/2" F	2	14	20.04	B



رشاش مدفعي -24°

D"	Pcs/Bag	Pcs/Box	Kg/Box	Box Type
1-1/2" Flange	-	-	-	B



رشاش مدفعي

D"	Pcs/Bag	Pcs/Box	Kg/Box	Box Type
1-1/4" F	-	-	-	B

رشاش مدفعي

تعديل النزول من (0°-48°)

رشاش مدفعي

(قاعدة ألومنيوم)



D"	Pcs/Bag	Pcs/Box	Kg/Box	Box Type
1-1/2" Flange	-	-	-	B



D"	Pcs/Bag	Pcs/Box	Kg/Box	Box Type
1-1/2" F	-	-	-	B

رشاش مدفعي -24°



رشاش مدفعي -24°

D"	Pcs/Bag	Pcs/Box	Kg/Box	Box Type
2" F	-	-	-	B



D"	Pcs/Bag	Pcs/Box	Kg/Box	Box Type
2" F	-	-	-	B



-43°

رشاش مدفعي

D"	Pcs/Bag	Pcs/Box	Kg/Box	Box Type
2" Flange	1	-	-	B

رشاش مدفعي

تعديل النزل من (0°-48°)



D"	Pcs/Bag	Pcs/Box	Kg/Box	Box Type
2" Flange	1	-	-	B

-24°

رشاش مدفعي



D"	Pcs/Bag	Pcs/Box	Kg/Box	Box Type
2" F	1	-	-	B

رشاش مدفعي

تعديل النزل من (0°-48°)



D"	Pcs/Bag	Pcs/Box	Kg/Box	Box Type
2-1/2" Flange	1	-	-	B

-43°

رشاش مدفعي



D"	Pcs/Bag	Pcs/Box	Kg/Box	Box Type
2" F	1	-	-	B

-18°

رشاش مدفعي



D"	Pcs/Bag	Pcs/Box	Kg/Box	Box Type
2" Flange	1	-	-	B

رشاش مدفعي

زاوية قابلة للتعديل



D"	Pcs/Bag	Pcs/Box	Kg/Box	Box Type
3" Flange	1	-	-	B

-24°

رشاش مدفعي



D"	Pcs/Bag	Pcs/Box	Kg/Box	Box Type
2" Flange	1	-	-	B

قطع ري من الحديد والحديد الدكتايل

وصلة فك وتركيب



Size	weight kg/pc
DN100MM PN16	22
DN150MM PN16	30
DN200MM PN16	43
DN250MM PN16	55
DN300MM PN16	84
DN400MM PN16	147.5
DN500MM PN16	229
DN600MM PN16	314

فلنجة R/J



Size	weight kg/pc
R/J 90MM	6.5
R/J 110MM	7
R/J 160MM	10
R/J 200MM	15
R/J 225MM	19
R/J 250MM	25
R/J 315MM	35

جلبة اصلاح من الاستانلس ستيل



Size	weight kg/pc
62-76MM	1.3
88-103MM	2.05
108-118MM 20C	2.05
108-118MM 30C	3.05
124-138MM 20C	
158-172MM 20C	2.52
158-172MM 30C	3.74
190-210MM 20C	4.2
215-235MM 30C	6.8
240-260MM 30C	7
272-289MM 30C	7.5
313-336MM 30C	8.6
313-336MM 60C	17.2
29-33MM 7C	0.26
38-42MM 7C	0.28
48-51MM 7C	0.3
60-65MM 7C	0.34
220-230MM 30CM	5.12
38-43MM 15CM	0.54
48-55MM 15CM	1.2
61-65MM 15CM	1.24

صفاية واي



Size	weight kg/pc
DN 80MM PN 16	50
DN 100MM PN 16	100
DN 150MM PN 16	100
DN 200MM 8H PN 16	50
DN 200MM 12H PN 16	25

محبس بوابة بفلنجة



size	weight kg/pc
DN50MM PN16	7
ON65MM PN16	8.6
DN80MM PN16	10.5
DN100MM PN16	12.4
DN125MM PN16	19
DN150MM PN16	23.6
DN200MM 8H PN16	38.7
DN200MM 12H	38.7
DN250MM PN16	61
DN300MM PN16	84
DN400MM PN16	190

رداد بفلنجة

Size	weight kg/pc
DN65MM PN16	12
DN80MM PN16	16
DN100MM PN16	23
DN150MM PN16	53
DN200MM 8H	53
DN200MM 12H	69
DN250MM PN16	103
DN300MM PN 16	12



وصلة بفلنجة



Size	weight kg/pc
80 MM	25
100 MM	25
150 MM	25
200 MM	25
200 MM 12 Hole	25
3 INCH	25
4 INCH	25
6 INCH	25
8 INCH	25
8 INCH 12 Hole	25

مدول فلنجة



Size
58-72MM PN16
72-85MM PN16
88-103MM PN16
105-125MM PN16
155-175MM PN 16
192-210MM PN 16
218-235MM PN 16
272-289MM PN 16
310-330MM PN 16
340-360MM PN 16
351-378MM PN 16
390-410MM PN 16
400-430MM PN 16
417-437MM PN 16
425-442MM PN 16
436-462MM PN 16
455-475MM PN 16
476-500MM PN 16
490-510MM PN 16
500-532MM PN 16
526-546MM PN 16
600-630MM PN 16
630-650MM PN 16
398-430MM PN 16

وصلة



Size
58-72MM PN16
72-85MM PN16
88-103MM PN16
105-125MM PN16
108-128MM PN16
125-140MM PN16
132-154MM PN16
155-175MM PN16
158-182MM PN16
192-210MM PN16
218-235MM PN16
218-244MM PN16
272-289MM PN16
310-330MM PN16
315-335MM PN16
340-360MM PN16
351-378MM PN16
374-391MM PN16
390-410MM PN16
400-430MM PN 16
417-437MM PN16
417-447MM PN16
425-442MM PN16
436-462MM PN16
455-475MM PN16
476-500MM PN16
500-532MM PN16
526-546MM PN16
600-630MM PN16
630-650MM PN16
800-825MM PN16

محبس طارة (سوكت)



Size	weight kg/pc
DN50MM PN16	6.7
DN65MM PN16	6.7
DN80MM PN16	9.2
DN100MM PN16	11.4
DN125MM PN16	21.6
DN150MM PN16	21.6
DN200MM PN16	34

محبس هواء مزدوج

Size	weight kg/pc
80 mm	21
100 mm	25
150 mm	45
200 mm	136
80 mm	21



محبس طارة (سوكت)

Size	weight kg/pc
DN50MM PN16	8.5
DN65MM PN16	13.5
DN80MM PN16	13.5
DN100MM PN16	16.5
DN125MM PN16	30
DN150MM PN16	30
DN200MM PN16	49



عمود اسبنديل

Size	weight kg/pc
4' 5' 6' 8 inch all size in one	5



غطاء شارع

Size	weight kg/pc
4 Inch to 8 Inch	6



شفاط بفلنجة

Size	weight kg/pc
DN 80 MM	8.5
DN 100 MM	9.5
DN150 MM	17
NGDN200 MM	26
DN200 MM 12 HOLE	26



مشبك فلازي مقاوم للصداء



Size	weight kg/pc
62-76MM	1.65
88-103MM	1.8
108-118MM	1.8
108-118MM	1.8
124-138MM	1.97
158-172MM	2.15
158-172MM	2.15
190-210MM	2.27
215-235MM	2.3
240-260MM	2.41
272-289MM	2.5
all size clamp out 1 inch	
all size clamp out 2 inch	

محبس فحص فراشة

Size	weight kg/pc
DN50MM PN16	1.52
DN65MM PN16	2.12
DN80MM PN16	3.15
DN100MM PN16	4.48
DN125MM PN16	5.72
DN150MM PN16	8.74
DN200MM PN16	14.2

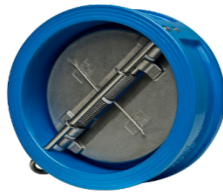

فلنجة سدة



size	MATREL	THICKNESS
2"	CARBON STEEL	10MM
3"	CARBON STEEL	10MM
4"	CARBON STEEL	10MM
5"	CARBON STEEL	10MM
6"	CARBON STEEL	10MM
7"	CARBON STEEL	10MM
8"	CARBON STEEL	10MM
10"	CARBON STEEL	12MM
12"	CARBON STEEL	12MM

فلنجة لحام



size	MATREL	THICKNESS
2"	CARBON STEEL	10MM
3"	CARBON STEEL	10MM
4"	CARBON STEEL	10MM
5"	CARBON STEEL	10MM
6"	CARBON STEEL	10MM
7"	CARBON STEEL	10MM
8"	CARBON STEEL	10MM
10"	CARBON STEEL	12MM
12"	CARBON STEEL	12MM

فلنجة بسنة



size	MATREL	THICKNESS
2"	CARBON STEEL	10MM
3"	CARBON STEEL	10MM
4"	CARBON STEEL	10MM
5"	CARBON STEEL	10MM
6"	CARBON STEEL	10MM
7"	CARBON STEEL	10MM
8"	CARBON STEEL	10MM
10"	CARBON STEEL	12MM
12"	CARBON STEEL	12MM

فلنجة شفة



size	MATREL	THICKNESS
2"	CARBON STEEL	10MM
3"	CARBON STEEL	10MM
4"	CARBON STEEL	10MM
5"	CARBON STEEL	10MM
6"	CARBON STEEL	10MM
7"	CARBON STEEL	10MM
8"	CARBON STEEL	10MM
10"	CARBON STEEL	12MM
12"	CARBON STEEL	12MM



الأطوال القياسية

- حتى قطر 125 مم: لفائف بطول 100 متر
- أقطار 140-250 مم: أطوال مستقيمة 12 متر
- أطوال وألوان أخرى متاحة عند الطلب

الخامة

- بولي إيثيلين عالي الكثافة (HDPE)
- MRS يساوي 10 ميغا باسكال
- os يساوي 8 ميغا باسكال
- معامل الأمان = 1.25
- اللون: أسود (للمياه)

المعادلات

- الطغظ الإسمي (PN):

$$PN = \frac{2 \times \sigma s \times s \times 10}{Da - s}$$

- سلسلة الأنبوب:

$$Series = \frac{\sigma s \times 10}{PN}$$

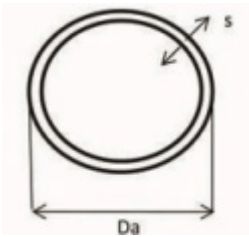

ملاحظات

- الوزن قد يختلف حسب كثافة البوليمر.
- تم الحساب على أساس كثافة متوسطة 0.95 جم/سم³.
- للكثافات الأخرى، يتم تحديد الكتلة عن طريق الاستيفاء.
- يتوافق مع معايير DIN 8074 / 8075 لتصنيفات وأبعاد PN/SDR.

التعريفات الأساسية

الوصف	الرمز
الضغط الإسمي (بار)	N
وزن الأنبوب (كجم/متر)	Wt
سُمك الجدار (مم)	s
القطر الخارجي الإسمي (مم)	Dia
نسبة الأبعاد القياسية (القطر/السُمك)	SDR
الحد الأدنى للقوة المطلوبة (ميغا باسكال)	MRS

HDPE									
DA mm	6 BAR			10 BAR			16 BAR		
	THICKNE SS mm	Nominal pipe ID mm	Q= A*V(1.5) M3/HR	THICKNE SS mm	Nominal pipe ID mm	Q= A*V(1.5) M3/HR	THICKNE SS mm	Nominal pipe ID mm	Q= A*V(1.5) M3/HR
25				1.8	21.4	1.94	2.8	19.4	1.59
32	1.8	28.4	3.4	1.9	28.2	3.4	2.9	26.2	2.8
50	2	46	9	3	44	8.2	4.6	40.8	7.1
63	2.5	58	14.3	3.8	55.4	13	5.8	51.4	11.2
75	2.9	69.2	2.3	4.5	66	18.5	6.8	61.4	16
90	3.5	83	29.2	5.4	79.2	26.6	8.2	73.6	23
110	4.2	101.6	43.8	6.6	96.8	39.7	10	90	34.3
125	4.8	115.4	56.5	7.4	110.2	51.5	11.4	102.2	44.3
160	6.2	147.6	92.3	8.5	143	86.7	14.6	130.8	72.5
180	6.9	166.2	117.1	10.7	158.6	106.6	16.4	147.2	91.8
200	7.7	184.6	144.5	11.9	176.2	131.6	18.2	163.6	113.5

S. No.	Description	HDPE Pipe Availability by Pressure Rating		
		6 BAR	10 BAR	16 BAR
1	13 MM	✓	-	-
2	16 MM	✓	-	-
3	20 MM	✓	✓	✓
4	19 MM	✓	✓	✓
5	25 MM	✓	-	-
6	32 MM	✓	✓	✓
7	40 MM	✓	✓	✓
8	50 MM	✓	✓	✓
9	63 MM	✓	✓	✓
10	75 MM	✓	✓	✓
11	90 MM	✓	✓	✓
12	110 MM	✓	✓	✓
13	125 MM	✓	✓	✓
14	160 MM/meter	✓	✓	✓

لي موسمي

لي Apollo للري بالتنقيط يمكن أن يساعدك في تحسين المحصول، وكفاءة استخدام المياه، وجودة المحاصيل عن طريق إيصال المياه والأسمدة مباشرة إلى حيث تحتاجها النباتات. لي Apollo هو شريط ري بالتنقيط يستخدم متاهة مستمرة (تصميم داخلي) مثالي لتقليل المسافات بين نقاط التنقيط، مما يجعله مناسبًا لزراعة الخضروات والزهور. تقليل المسافة بين النقاط ومعدل التدفق المنخفض يضمن أداءً ممتازًا حتى في التربة الرملية جدًا.

مخرج ماء بشق مانع للارتجاع

فتحة خفية لخروج المياه تمنع تسلل الجذور وتقوم بوظيفة منع الارتجاع.

متاهة واسعة المقطع

تصميم متوازن مقطعيًا يزيد من اضطراب وسرعة تدفق المياه.

فلتر دخول

مرشحات داخلية تمنع الجزيئات من دخول المتاهة.

تدفق مضطرب

مسارات تدفق محسنة تقلل احتمالية الانسداد.

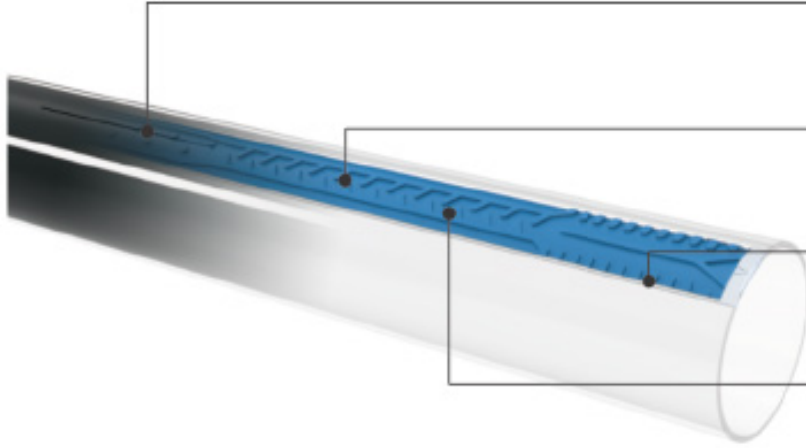

لي الري بالتنقيط ذو النقاط المسطحة

• معدلات التدفق (لتر/ساعة):

2.2, 2.0, 1.6, 1.0

• المسافة بين النقاط (سم):

45, 40, 35, 30, 25, 20, 15, 10

• السُمك (ميل):

12, 10, 8, 7, 6

• الطول/اللفة (متر):

3000, 2500, 2000, 1500, 1000, 500, 350, 100



لي الري بالتنقيط بمتاهة متصلة بدون فواصل

• معدلات التدفق (لتر/ساعة):

2.5, 2.2, 1.8, 1.5, 1.3, 1.1, 0.9, 0.6

• المسافة بين النقاط (سم):

60, 50, 45, 40, 30, 20, 10

• السُمك (ميل):

12, 10, 8, 7, 6

• الطول/اللفة (متر):

3000, 2500, 2000, 1500, 1000, 500, 350, 100



لي تنقيط

الفوائد والمميزات

- جميع الأنابيب مصنعة بحماية من الأشعة فوق البنفسجية والأكسدة، مما يجعلها مقاومة لأشعة الشمس دون ضرر كبير ولمدة سنوات عديدة.
- الكائنات الدقيقة أو الفطريات لا تهاجم أنابيب PE سواء من الداخل أو الخارج.
- أنابيب PE مقاومة للمياه المالحة، والحلول الحمضية أو القلوية (باستثناء الحلول عالية التركيز)، ومعظم المواد المستخدمة في التطبيقات الزراعية.
- متوفرة بأطوال قياسية للملفات، أو بكرات ذات أقطار كبيرة، أو قضبان أنابيب لتلبية المتطلبات المحددة.
- مصنوعة من راتنج البولي إيثيلين منخفض أو متوسط الكثافة، تم تركيبه خصيصاً لمقاومة التشقق والانثناء، ولضمان الاعتمادية على المدى الطويل.
- تصنيع بدقة لضمان تجانس القطر الداخلي وسُمك الجدار.
- تحتوي على مواد معاد تدويرها تسهم في تحقيق الاقتصاد الدائري وتساعد المزارعين في تحقيق أهداف الاستدامة البيئية (ESG).
- ضمان لمدة 5 سنوات: يقدم ضماناً متميزاً على جميع الأنابيب المصنوعة من البولي إيثيلين بقطر 1.0 مم فما فوق.

أقطار وأطوال متعددة

Product Name	Pipe (mm)		Ø 16		Operating Pressure (bar)	CV%
	Wall Thickness	Discharge rate	inside	Outside		
Reef 80	0.8	2,4 and 6	14.00	15.60	0.5-30	<5
Reef 100	1.0	24 and 6	14.00	16.00	0.5-40	<5

Maximum lateral length (m) on flat ground at different discharge variations*

Discharge Variation %	Dripper Spacing (cm)	Maximum lateral length (m) on flat ground at different discharge variations*																	
		33			40			50			60			75			100		
		2.0	4.0	6.0	2.0	4.0	6.0	2.0	4.0	6.0	2.0	4.0	6.0	2.0	4.0	6.0	2.0	4.0	6.0
5	16 Ø	49	41	30	55	45	34	58	51	42	66	58	48	82	70	54	99	85	67
10		62	51	36	66	55	41	75	64	50	97	74	55	103	82	65	136	105	go
15		68	56	41	72	61	48	88	74	56	96	82	64	112	98	81	144	123	96
20		76	62	45	89	74	54	101	84	62	112	95	73	124	110	91	168	141	105

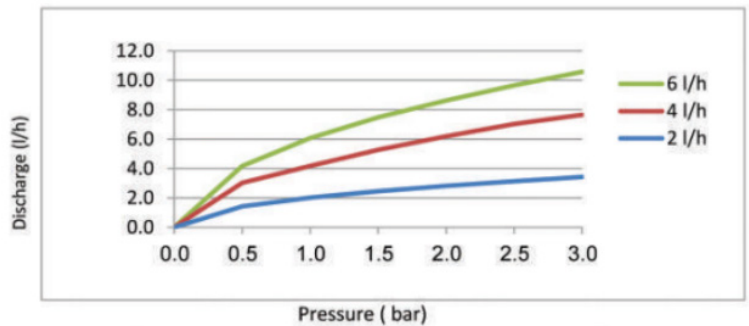



للتواصل

+966552462950

+966504886962

osooltrading.co@outlook.sa

www.osoolagre.com